

MOCET

IP3062 Professional IP Phone User Guide



FCC Statement

This equipment generates, uses and can radiate radio frequency energy and, if not installed and used in accordance with the instructions in this guide, may cause interference to radio communications. This equipment has been tested and found to comply with the limits for a Class B computing device pursuant to Subpart J of Part 15 of FCC rules, which are designed to provide reasonable protection against radio interference when operated in a commercial environment. Operation of this equipment in a residential area is likely to cause interference, in which case the user, at his own expense, will be required to take whatever measures are necessary to correct the interference.

CE Declaration of Conformity

This equipment complies with the requirements relating to electromagnetic compatibility, EN55022 class B for ITE and EN 50082-1. This meets the essential protection requirements of the European Council Directive 89/336/EEC on the approximation of the laws of the Member States relating to electromagnetic compatibility.

Environment

The phone you have purchased, as well as any used batteries must not be disposed of with household waste. You should return these to your distributor if they are to be replaced or disposed of them in an approved recycling center.

Trademarks

Windows 98/2000/NT/NT™ and Internet Explorer™ are registered trademarks of Microsoft Corporation. All other company, brand and product names, like Metaswitch™, Broadsoft™, Freeswitch™ and Asterisk™ are registered trademarks of their respective owners.

WARNING!



1. Read these installation instructions carefully before connecting the IP phone to its power.
2. To reduce the risk of electric shock, do not remove the cover from the IP phone or attempt to dismantle it. Opening or removing covers may expose you to dangerous voltage levels. Equally, incorrect reassembly could cause electric shock on re-use of the appliance.
3. Do not expose the IP Phone to Fire, direct sunlight or excessive heat.
4. Do not expose the IP Phone to rain or moisture and do not allow it to come into contact with water.
5. Do not install the IP phone in an environment likely to present a THREAT OF IMPACT.
6. You may clean the IP phone using a fine damp cloth. Never use solvents (such as trichloroethylene or acetone), which may damage the phone's plastic surface and LCD screen. Never spray the phone with any cleaning product whatsoever.
7. Take care not to scratch the LCD screen.
8. The IP phone is designed to work in temperatures from 5°C to 40°C.
9. The IP phone must be installed at least 1 meter from radio frequency equipment, such as TVs, radios, hi-fi or video equipment (which radiate electromagnetic fields).
10. Do not connect the LAN/PC port to any network other than an Ethernet network.
11. Do not attempt to upgrade your IP phone in an unstable power environment. This could cause unexpected issues.
12. Do not work on the system or connect or disconnect cables during lightning storms.
13. Children don't recognize the risks of electrical appliances. Therefore use or keep the phone only under supervision of adults or out of the reach from children.
14. No repair can be performed by the end user, if you experience trouble with this equipment, for repair or warranty information, please contact your supplier.

Table of Content

About this Guide	6
Overview	7
1. Introduction	8
1.1. Phone Features and Specifications.....	9
1.2. Requirements	9
1.3. Installation and Setup.....	9
1.3.1. <i>Attaching the Stand to the Phone</i>	9
1.3.2. <i>Detaching the Stand from the Phone</i>	10
1.3.3. <i>Installation Combination Table</i>	11
1.3.4. <i>Connect the Handset and Power Adapter to the Phone</i>	12
1.3.5. <i>Connect the Ethernet Cables</i>	12
1.4. Appearance and Function Description.....	13
1.5. IP3062 Port Functions.....	16
1.6. IP3062 LED Functions.....	17
1.7. LCD Screen Indicators	18
2. Getting Started	20
2.1. Customizing Your IP Phone from Menu	20
2.2. Configuring Basic Settings	21
2.2.1. <i>Volume Setting</i>	21
2.2.2. <i>LCD Brightness</i>	22
2.2.3. <i>LCD Contrast</i>	22
2.2.4. <i>Call Setting</i>	22
2.2.5. <i>Lock Your Phone</i>	22
2.2.6. <i>Speed Dialing Setting</i>	23
2.2.7. <i>Reboot Your phone</i>	23
2.3. Managing Contacts	23
2.3.1. <i>Adding Contacts</i>	24
2.3.2. <i>Editing Contacts</i>	24
2.3.3. <i>Deleting Contacts</i>	25
2.3.4. <i>Searching for a Contact</i>	25
2.3.5. <i>Placing a Call to a Contact</i>	25
2.4. Managing Call Logs.....	25
2.5. Viewing Your Phone's Information	26
2.6. Configuring An Extended Dial Module (EDM) Setting	26

2.7.	Configuring Programmable Keys.....	27
2.8.	Managing Voice Mail	27
2.9.	Managing Instant Message	27
2.10.	Viewing Notifications	28
3.1.	Common Terms.....	29
3.1.1.	<i>Lines</i>	29
3.1.2.	<i>Calls</i>	29
3.1.3.	<i>Registration</i>	29
3.1.4.	<i>Caller ID</i>	30
3.2.	Installing Your IP Phone	30
3.3.	Configuring Your IP Phone for Service.....	30
3.4.	Line Selection.....	30
3.5.	Placing a Call	31
3.6.	Placing an Urgent Call.....	31
3.7.	Adjusting Call Volume	32
3.8.	Canceling a Call	32
3.9.	Answering a Call	33
3.10.	Answering an Urgent Call.....	33
3.11.	Rejecting a Call	33
3.12.	Ending and Holding and Resuming a Call.....	34
3.13.	Muting and Un-muting a Call	35
3.14.	Redialing a Number.....	35
3.15.	Setting up a Conference Call.....	35
3.16.	Transferring a Call	35
3.16.1.	<i>Blind Transfer</i>	36
3.16.2.	<i>Semi-Attended Transfer</i>	36
3.16.3.	<i>Attended Transfer</i>	36
3.17.	Forwarding a Call	36
3.18.	Using Voice Mail.....	36
3.19.	Placing a Speed Dial Call.....	37
3.20.	Using Multiple Lines	37
3.21.	Using Multiple Calls.....	39
4.	Using Advanced Features	40
4.1.	Login Web UI.....	40
4.2.	Changing the User's Password	40
4.3.	Viewing Phone Information on Web User Interface.....	41

4.4.	Configuring Phone Settings.....	41
4.5.	Managing Programmable Keys	43
4.6.	Configuring SIP Line Settings.....	44
4.7.	Configuring System Settings	44
4.8.	Managing EDM.....	45
4.9.	Managing Phonebook.....	45
4.9.1.	<i>Private Phonebook</i>	45
4.9.2.	<i>Public Phonebook</i>	45
4.9.3.	<i>LDAP Directory</i>	45
4.10.	Placing a Call from the Private Phonebook	46
4.11.	Sending an Instant Message (IM).....	46
5.	Using Advanced Call Features	47
5.1.	Centralized Conferencing (for Broadsoft PBX)	47
5.2.	Call Waiting	47
5.3.	Intercom Call	47
5.3.1.	<i>Answering an Intercom Call</i>	47
5.3.2.	<i>Placing an Intercom Call</i>	47
6.	Phone Firmware Upgrade	49
7.	Using USB Devices with Your Phone	50
7.1.	USB Keyboard.....	50
7.2.	USB Memory Dongle.....	50
7.3.	USB WLAN Dongle	51
8.	Troubleshooting.....	52
9.	Glossary.....	53
9.1.	Acronyms	53
9.2.	Terminology.....	54



About this Guide

This guide explains how to use the basic features of your new IP3062 phone. Not all features listed are available by default. Contact your system or network administrator to find out which features and services are available to you on your system.

Your System Administrator has the ability to customize some features on this phone. For information on more advanced settings and configurations, administrators should refer to the IP3062 Professional IP Phone Administrator Guide.

Overview

The MOCET IP3062 Professional IP Deskphone has more features than the lower cost IP3032 Standard IP Deskphone. The following table highlights the differences between the two phones:

Features	IP3032	IP3062
Appearance		
LCD	128 x 32 pixels	128 x 64 pixels
Physical line keys	2 keys	4 keys
10M/100M Ethernet	1 port: LAN	2 ports: LAN , PC
Programmable keys	8 keys	16 keys
Headset connector	No	Yes
Headset button	No	Yes
Line switch button	Yes	No
USB Type A Port	No	Yes
USB Mini b Port	No	Yes
EDM Port	No	Yes
AC adaptor	5V/ 550mA	5V/ 2A
Voice Codec	G.711 (A-law/Mu-law) G.729A/B	G.711 (A-law/Mu-law) G.729A/B G.722
Audio quality	Narrow Band	HD
Multiple call appearances	Up to 8 call appearances	Up to 16 call appearances
Conference	Up to 3-party	Up to 5-party
Accessories	No	IP-EDMX (up to 2pcs) Dedicated USB Wi-Fi adapter USB keyboard USB storage dongle USB hub

1. Introduction

The MOCET IP3062 Professional IP phone is an easy-to-use high quality desk phone with many advanced features including support for secure calling with trusted layer security (TLS) and Secure Real-time Transfer Protocol (SRTP), a built-in IP Security (IPSEC) virtual private network (VPN) client, and instant messaging capabilities. Utilizing a next generation capacitive touch sensitivity panel design, the IP3062 supports up to four simultaneous lines and can be positioned in multiple tilt angles and has a wall mount option, and has a built-in two port 10/100 Ethernet switch with automatic support for power over Ethernet (PoE). The IP3062 has 16 programable buttons and can be configured through the simple built in menus displayed on the blue backlit LCD or from the phone's web user interface. The IP3062 can be automatically provisioned from a local or Internet based server using the built-in MOCET auto-provisioning system and management protocols.

The IP3062 IP Phone supports many advanced features including 5-way on-phone conferencing, can transfer and receive calls using industry-standard SIP protocols, and can provide built-in music-on-hold (MoH) over IP network. The IP3062 is interoperable with a wide range of SIP services and servers including those based on Metaswitch™, Broadsoft™, Freeswitch™ and Asterisk™. Therefore, the IP3062 can be deployed and used anywhere there is a suitable local area network (LAN) with Internet access and a local or remotely hosted SIP server. Since it is a stand-alone and “always-on” device, it does not require connection to a computer for it to work.

In addition, the IP3062 has a large LCD display to show all calls in progress at once and supports HD audio through the use of the G.722 wideband codec, has a dedicated external headset port, USB 2.0 host type A and Mini type B ports, and an Extended Dial Module port. These functions make the IP3062 a more powerful and flexible IP phone to meet the demands of a busy professional user.

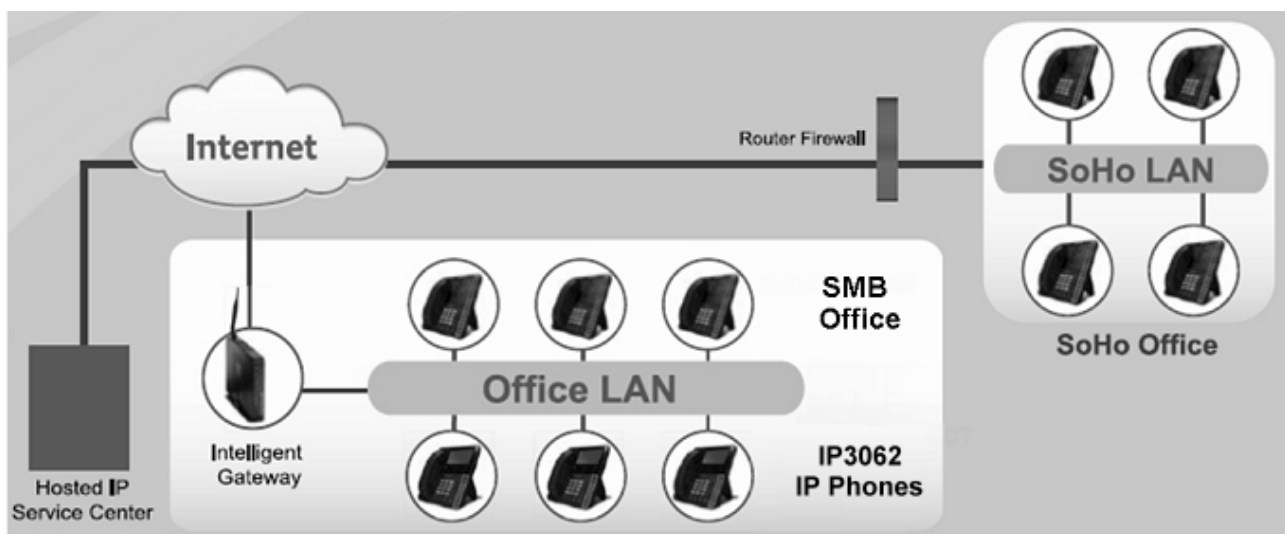

1.1. Phone Features and Specifications

- Complete VoIP and networking protocol support
- Rich supplementary call services and phone features
- HD acoustic hardware design for handset and speakerphone
- G.722 wideband audio codec support
- 4 SIP Lines with 16 call appearances
- Built-in two port 10/100 Ethernet switch
- 5-way on-phone conferencing
- 16 programmable keys with LEDs
- Interoperable with Asterisk, Freeswitch, Metaswitch and Broadsoft
- Auto-provisioning, remote management and security enhancements
- 802.11n Wi-Fi connection through an external Wi-Fi adapter
- External extended dial module to extend programmable keys

1.2. Requirements

The IP3062 IP Phone requires the following environments:

- Compatible SIP-based IP PBX system or Internet-based hosted SIP service account
- Ethernet/Fast Ethernet LAN (10/100 Base-T)

1.3. Installation and Setup

The IP3062 can support three different tilt angles of 60°, 51°, and 30° (see below).

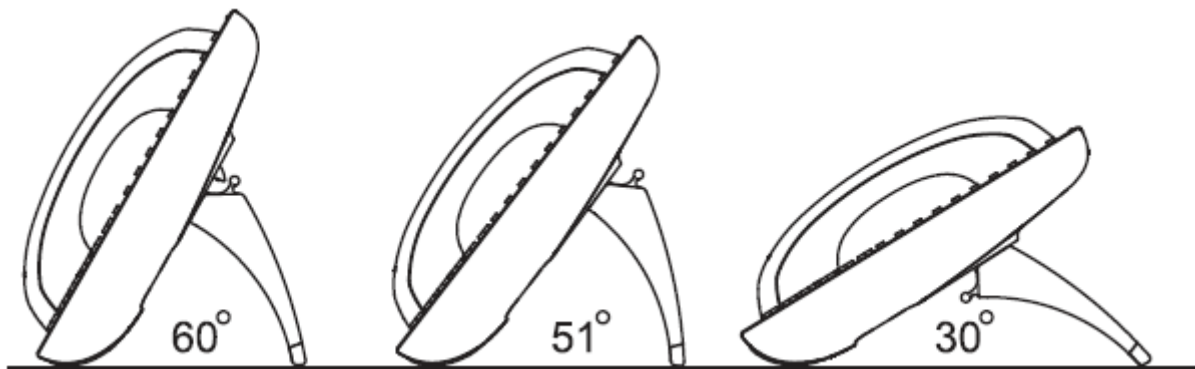

1.3.1. Attaching the Stand to the Phone

After unpacking the box, attach the stand to the IP3062 phone first. Below this paragraph we illustrate an example below of 60° angle installation with the stand. There are three sets of “antlers” on the top of the stand (named 1, 2 and 3) and there are three sets of mounting slots on the back of the phone (named A, B and C). See the illustration below.

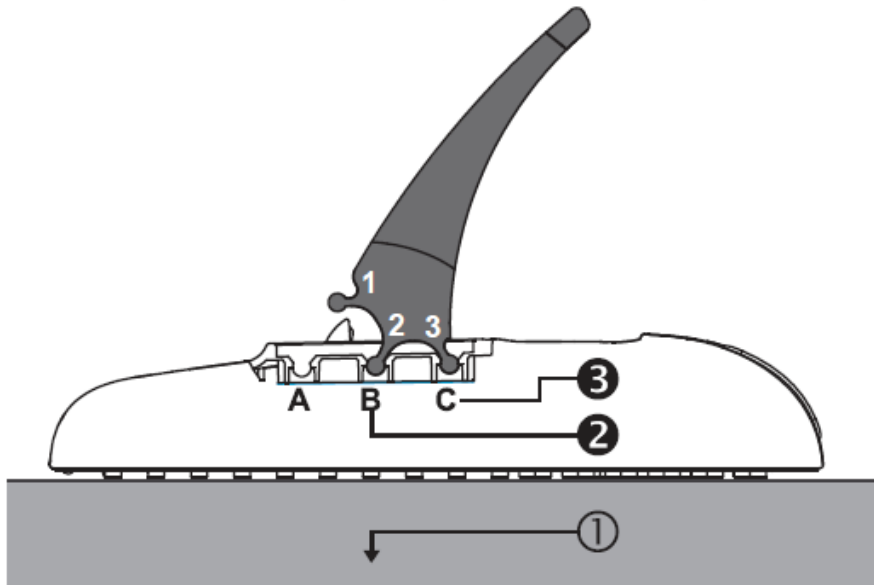

The procedures for attaching the stand to the phone are as follows :

- Step ①: Place the main body of the IP3062 face down on your lap or a firm sofa;
- Step ②: First snap the “2nd” antler into the slot “B” hole;
- Step ③: Then snap the “3rd” antler into the slot “C” hole (it may take a bit of pressure, but when it locks in place, you will hear a click and the stand will not wiggle on the phone.)

For other stand angle, such as 51° and 30°, please refer to the Installation Combination Table below to find correct slots and correct antlers to use.

CAUTION Snapping the slot “B” hole with the antler of stand first is the most important step for a smooth installation. The product sticker on stand should be facing inward towards the phone. When a stand is installed at 60° or 30°, you can rotate the stand between 30° and 60° quickly without pulling the antler in the slot B out.

1.3.2. Detaching the Stand from the Phone

To remove the stand from the IP3062 phone, follow the procedures below (we are using a 60° stand as an example):

- Step ①: Place the main body of the IP phone face down in your lap or a firm sofa;
- Step ②: Press with one hand on the back of the IP phone and firmly pull the the “3rd” antler straight out of the slot “C” hole;
- Step ③: Press with one hand on the back of the IP phone and firmly pull the the “2nd” antler straight out of the slot “B” hole.

1.3.3. Installation Combination Table

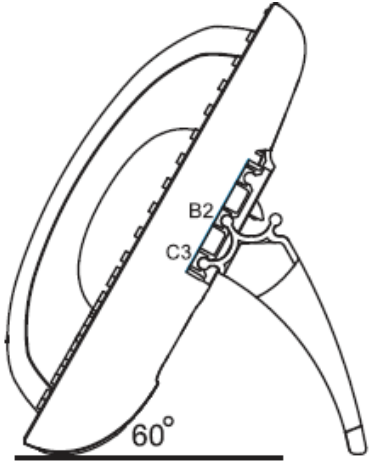
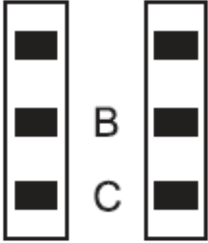
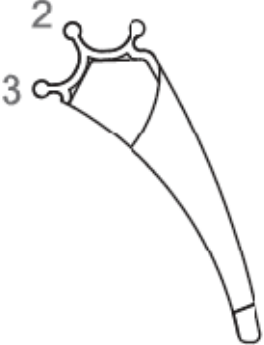
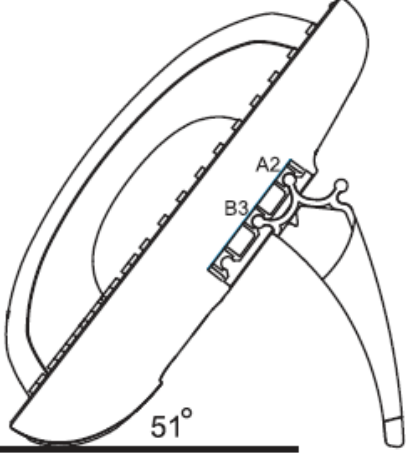
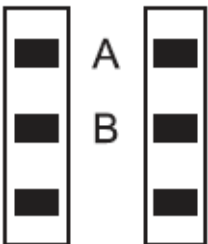
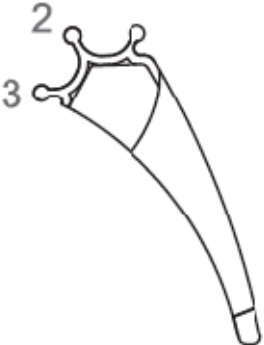
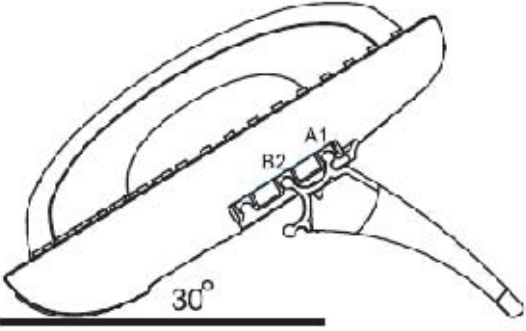
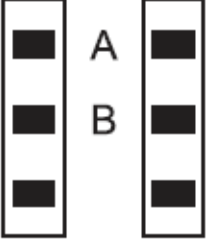
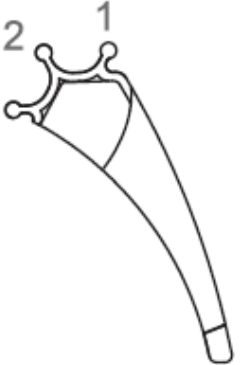
<i>Different Tilt Angle Installation</i>	<i>Slot Holes on the Back Shell</i>	<i>Antlers of Stand</i>
 <p>60°</p>		
	<p>B</p>	<p>2</p>
	<p>C</p>	<p>3</p>
 <p>51°</p>		
	<p>B</p>	<p>3</p>
	<p>A</p>	<p>2</p>
 <p>30°</p>		
	<p>B</p>	<p>2</p>
	<p>A</p>	<p>1</p>

1.3.4. Connect the Handset and Power Adapter to the Phone

After unpacking the box, connect the handset to the curly handset cord and then connect the other end of the curly handset cord to the port marked HAND with the handset icon on the bottom of the IP3062. Then connect the included power adapter to the port on the bottom of the phone marked 5VDC. Please make sure you use the right power adapter. It will have a label showing 5V and 2A. In some cases, power will be provided from your network's Ethernet switches and you will not need to use the included power adapter. Please check with your network or site administrator for more details on whether your network supports PoE. And the PoE power specification is compliant IEEE802.3af with Class 2 level. Please review the following diagram for more assistance.

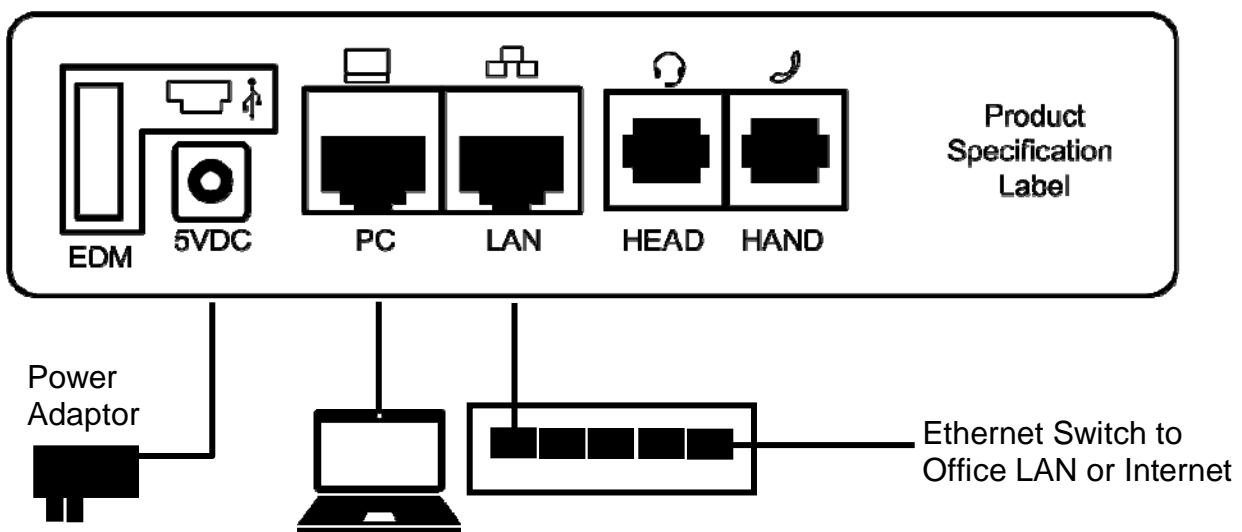



1.3.5. Connect the Ethernet Cables

Using a general CAT-5 Ethernet cable, follow the installation steps below:

If your Ethernet Switch supports PoE:

- Please connect an Ethernet cable to the Switch port from the LAN port  of the IP3062. Then you will see the phone LEDs and buttons light up momentarily and the phone will boot.

If your Ethernet Switch doesn't support PoE:

- Please connect an Ethernet cable to the Switch port from the LAN port  of the IP3062. Plug in the included power adaptor to the wall power outlet then plug the barrel plug to the power port  on the back of the phone. You should see the phone LEDs and buttons light up momentarily and the phone will boot.







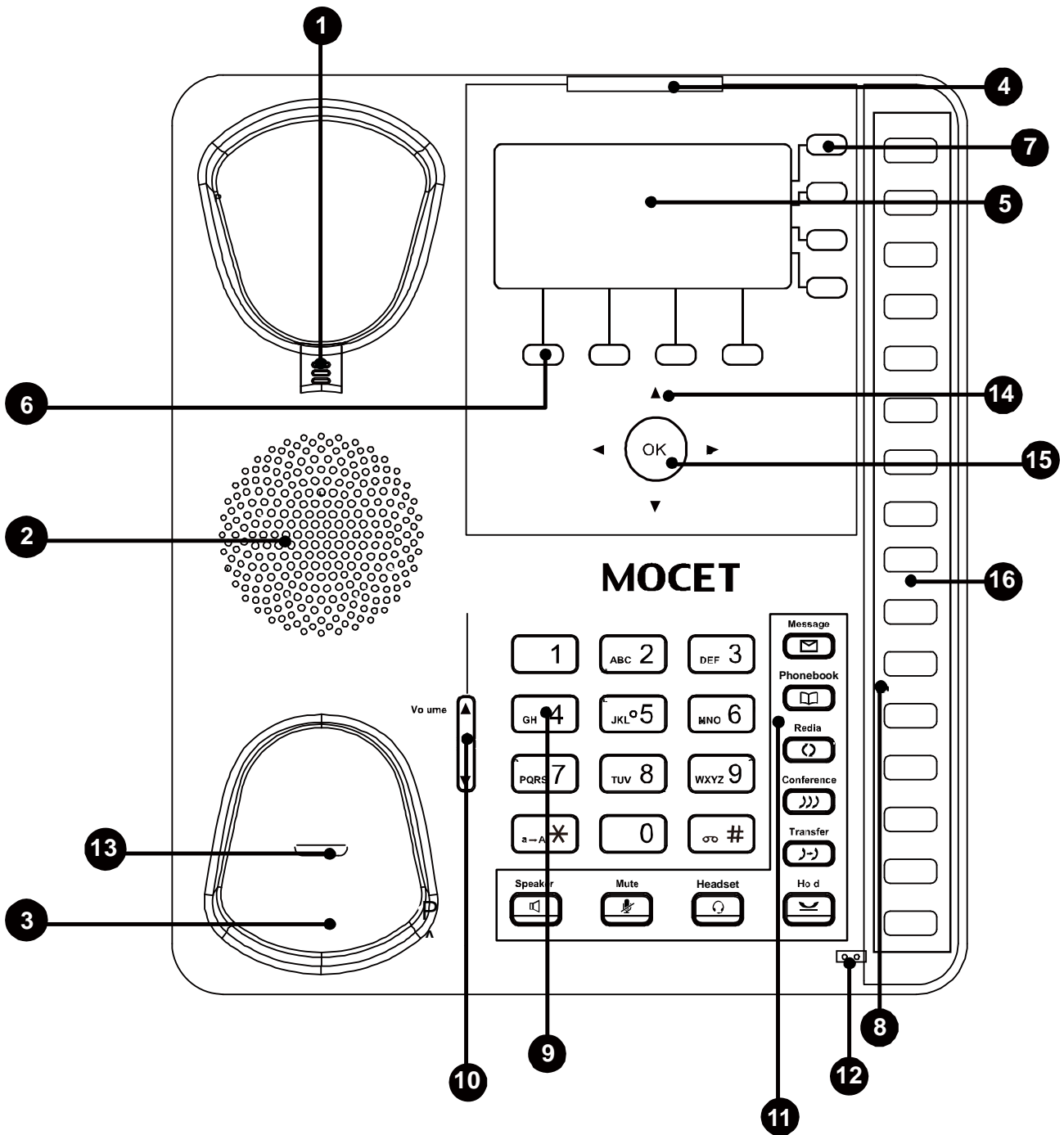

To eliminate the requirement for multiple Ethernet cables to a user's location, the user's computer can be connected to the network through the second Ethernet port  on the IP3062.

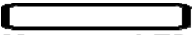









Notice : The IP3062 takes just under two minutes to start up and become operational. There are a series of LEDs and buttons that will light up periodically to provide boot progress information. Please be patient.

1.4. Appearance and Function Description

The IP3062 Professional IP Phone comes with a blue-green graphic LCD display, capacitive touch keys, including 4 soft keys, 4 line keys, and 5 navigator keys, as well as a traditional keypad, 16 programmable keys and 9 function keys. In the box, a handset, curly handset cord and a power adaptor supplied. It can be installed and placed on the desktop or mounted on the wall. The wall mount accessory is available separately. The figure below illustrates the front view of the IP3062 IP Phone. With the point numbers, you can find its name and a simple description of specified part in the following table.



No	Part Name	Description
1	Hanger	The hanger can be pulled; it is reversed for wall-mount installation.
2	Speaker	For ring and hands-free talking.
3	Hook switch & Handset bottom cradle	Under the cradle, a hook switch is used for handset hang-on and hang-off detection. The handset bottom cradle is for the placement of handset; placing the handset on the bottom cradle while on a call will end the call.
4	 Message LED	The message LED. Steady Blue means the phone is booting or upgrading
5	LCD Display	The LCD screen is used for displaying phone's settings, phone number, call status and so forth.
6	 Soft keys	Soft keys displayed on the LCD are used for item selection or control. The various soft key functions depend on the current activity on the phone as they are context-sensitive.
7	 Line keys	Line keys are used for line selection. A blue LED is associated with each key to indicate its line or call status.
8	 Programmable keys	Programmable keys can be used for indicating busy lamp field (BLF) status of other phones, speed dial phone numbers, or for activating features of a service or IP-PBX. A blue LED is associated with each key to indicate its status.
9	 Numeric keypad	[1], [2], ..., [9], [*], [0], [#]: The numeric keypad for dialing numbers.
10	 Volume Control key	The Volume Control key used to set the loudness of the ringer, handset and speakerphone functions. While the phone is in idle state, the Ringer is adjustable. While in a call, the Handset or Speaker volume is adjustable.
11	 Speaker Phone key	The SPKR key is used to activate or deactivate the Hands-free feature. A blue LED is used to indicate whether the speakerphone is active or not.
	 MUTE key	The MUTE key is used to activate or deactivate the microphones on the IP3062. A blue LED is used to indicate whether the phone is muted or not.

	 Headset key	<p>This headset key is used to activate or deactivate the external headset. A blue LED is lit to indicate active status.</p>
	 Hold key	<p>The Hold key is used to place the active call on hold. A blue LED is used to indicate whether the call is on hold or not.</p>
	 Message key	<p>The Message key is used to access the Voice Mail System for message retrieval.</p>
	 Phonebook key	<p>The Phonebook key is used to enter into the Phone Book menu to call, add, edit or delete a contact in a selected phonebook.</p>
	 Redial key	<p>The Redial key dials the last dialed number automatically.</p>
	 Conference key	<p>The Conference key is used to place multiple calls on the phone into a conference on the phone.</p>
	 Transfer key	<p>The Transfer key is used to transfer a call to another IP phone.</p>
12	 Hands-free MIC	<p>The Hands-free MIC. Note: You can use a paperclip to pick up the programmable key plate label (overlay) right here.</p>
13	 Handset LED	<p>The Handset LED is used to show the phone's status.</p>
14	 Navigator Control Keys	<p>The Navigation Control Keys are used for navigating the menus on the phone; menu items are displayed on the LCD screen.</p>
15	 Navigator OK Key	<p>The OK button is used to confirm and save a setting on the phone or to dial a phone number.</p>
16	Programmable key plate label	<p>The programmable key plate label is plastic. For best results, we recommend using a fine permanent marker (such as Sharpie brand) to write on it. It can be cleaned with industrial alcohol. Note: Custom templates and programming software for MOCET phones are available from DESI (see, http://labels.desi.com)</p>

1.5. IP3062 Port Functions

The back side view and the connectors of the IP3062 are as follows:

No	Part Name	Description
1	Handset Connector	RJ-9 jack for connecting handset cord.
2	Headset Connector	RJ-9 jack for connecting headset cord.
3	LAN Port	RJ-45 Jack 100/10Mbps Ethernet port for connecting to the local area network (LAN). This port can support power over Ethernet (PoE) if the LAN switch provides it.
4	PC Port	RJ-45 Jack 100/10Mbps Ethernet port for connecting to a computer.
5	Power Jack	If an external power source is required, the adaptor is plugged in here. Please use the power adaptor supplied in the package.
6	EDM Port	SATA interface for attaching the Extended Dial Module (EDM) accessory. Up to two EDM units can be supported on the IP3062.
7	USB Type A Port	USB 2.0 port with 5V/500mA power limitation (Can be used to connect supported accessories including Wi-Fi adapters, keyboards and memory devices.).
8	USB Mini b Port	USB 2.0 port with 5V/200mA power limitation (Can be used to connect supported accessories including Wi-Fi adapters, keyboards and memory devices.).

Their locations are shown in the figure below:

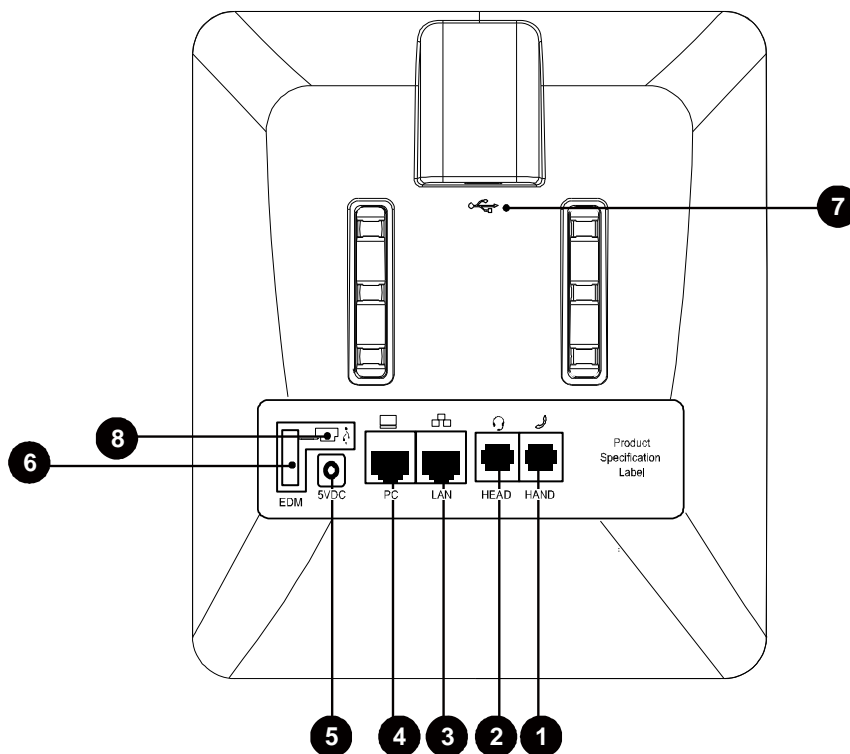

1.6. IP3062 LED Functions

The following table describes all functions of the LED indicators:

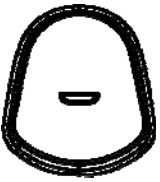



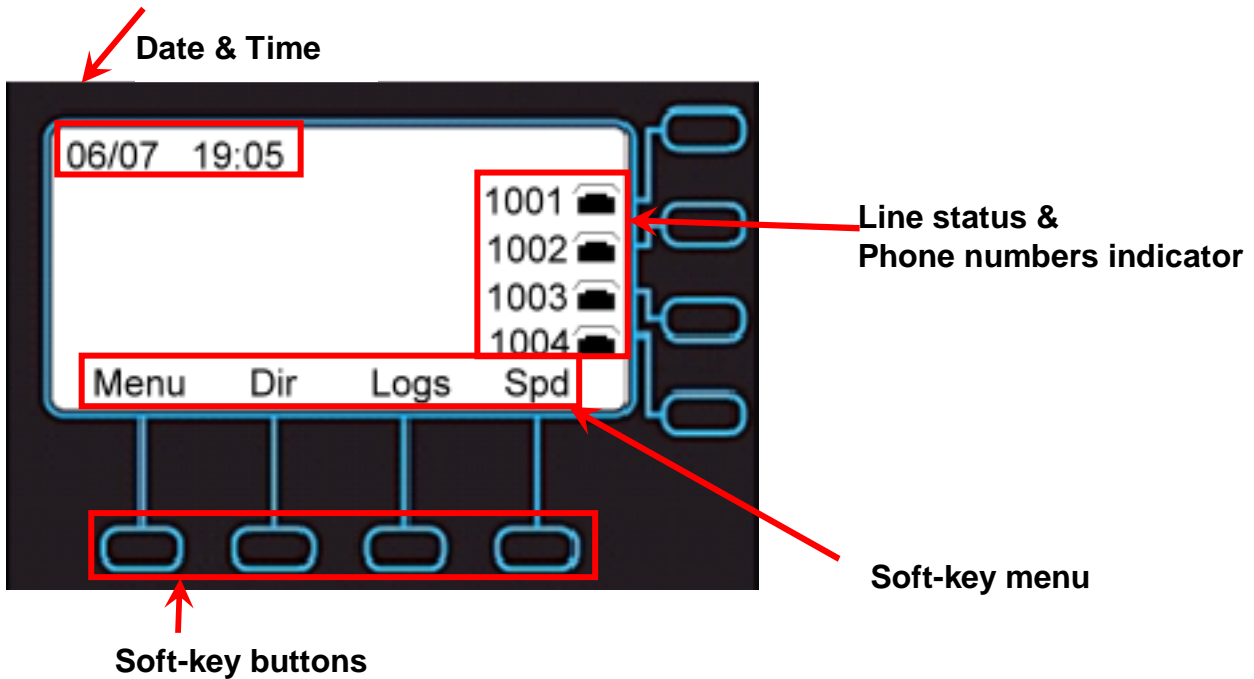

<i>LED</i>	<i>Color</i>	<i>Status</i>	<i>Description</i>
Message LED	Blue	Off	No new message(s).
		Steady	Phone is booting or upgrading.
		Blinking slow	New message(s) indication.
Programmable LED	Blue	Steady	Feature is set to "ON – Active". Or Phone is busy.
		Blinking slow	Incoming call notification.
		Off	Feature is set "Off-inactive".
Line LED	Blue	Steady	Line is active, dialing or in a call.
		Blinking slow	Call is on hold.
		Flashing faster	Incoming call.
Hold LED	Blue	Off	No call is on hold.
		Blinking slow	Call is placed on hold.
Speakerphone LED	Blue	Off	Speakerphone is not in use.
		Steady	On-hook dialing or hands-free mode.
MUTE LED	Blue	Off	Microphone is active.
		Steady	Microphone is inactive.
Headset LED	Blue	Off	Headset is not in use.
		Steady	Headset is in use.
 Handset LED	Red	Steady	The phone is booting.
		Flashing faster	The phone is upgrading or urgent call ringing; urgent call feature not available on all phone systems.
		Blinking slow	Link failure, SIP account expiration, or SIP Server not responding.
	Blue	Steady	The phone is in a normal idle state, or is during a call with G.722 codec by handfree or headset.
		Blinking slow	A normal incoming call with wideband G.722 codec notification.

1.7.LCD Screen Indicators

The following figure shows the standard display of the LCD. There are four soft keys associated with the operation of LCD display. For different menu or status items, the display items will change accordingly.



<i>Line Status Icon</i>	<i>Description</i>
	The line is registered to the SIP server or service.
	The line is not registered to the SIP server or service.
	The line is registered to the SIP server or service and is in use.
	The line is set for "Call Forwarding" to the configured number.
	The line is enabled both of "SIPs" and "SRTP".
	The line is enabled "SIPs" or "SRTP".
<i>Screen Icon</i>	<i>Description</i>
	IP3062 is on "Auto Answer" mode.
	IP3062 is on "Do Not Disturb" mode.

	<p>IP3062 is enabled "Phone Locked".</p>
	<p>IP3062 is connecting with an USB Wi-Fi dongle. To use Wi-Fi network connection, you need to use a specified USB Wi-Fi dongle. Please contact your distributor for purchasing.</p>
	<p>The Wi-Fi signal strength of IP3062 which is connecting to Wi-Fi network.</p>
	<p>IP3062 is connecting with an USB memory dongle.</p>
	<p>IP3062 is connecting with an USB keyboard.</p>
	<p>IP3062 is connecting with IP-EDMX. Each IP-EDMX can provide 24 programmable keys. To use over 16 programmable keys that IP3062 supports, you will need to have an IP-EDMX to expand. Please contact your distributor for purchasing.</p>

2. Getting Started

2.1. Customizing Your IP Phone from Menu

You can customize your IP phone by adjusting the settings including display contrast, ring type, device volume adjustment, call settings, and add, edit or delete contacts in the phonebooks of the IP3062 using the on-screen menus, buttons and navigation keys.

To configure your IP Phone from the menu, you can press **Menu** soft-key under the LCD screen.

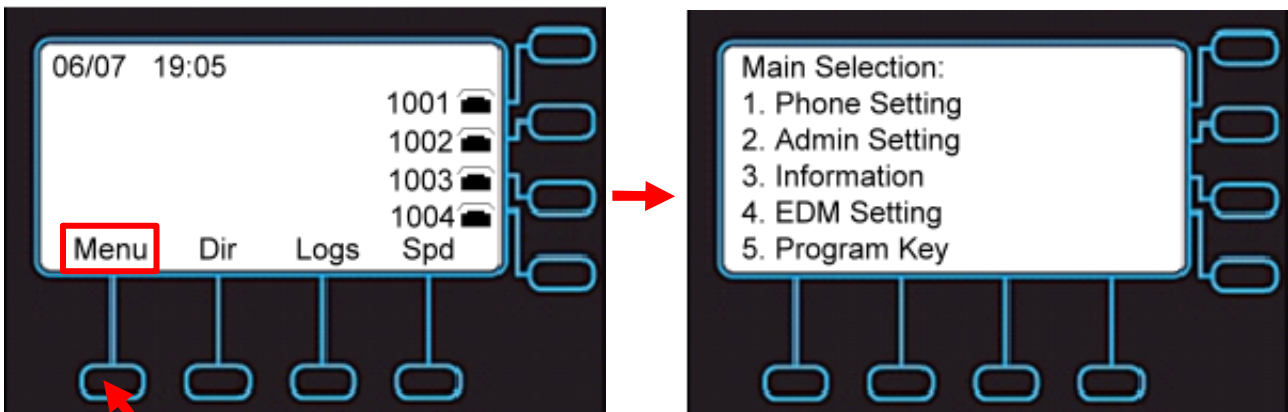

Press this key

You can navigate through the menu with the navigation keys. The following sections will describe how you can setup your IP Phone through this menu. If you require additional information or assistance with your new phone, contact your system administrator.

Note: changes to the phone settings will only become active after you exit from the menu and confirm the changes. The LCD will show the following screen to let you confirm your changes and exit the menu.

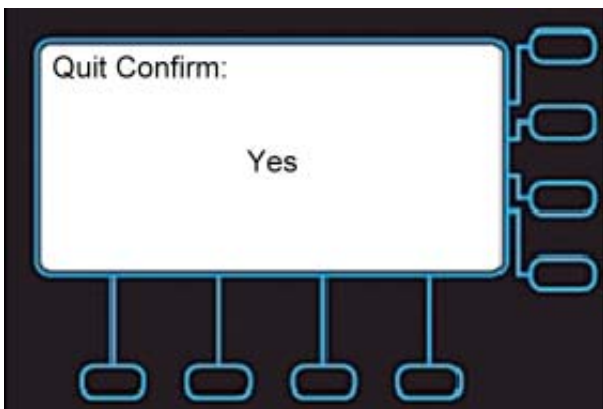

If you press **Navigation OK**, phone will save the settings.

If you press **Navigation Up and Down**, phone will change the screen to the following screen:

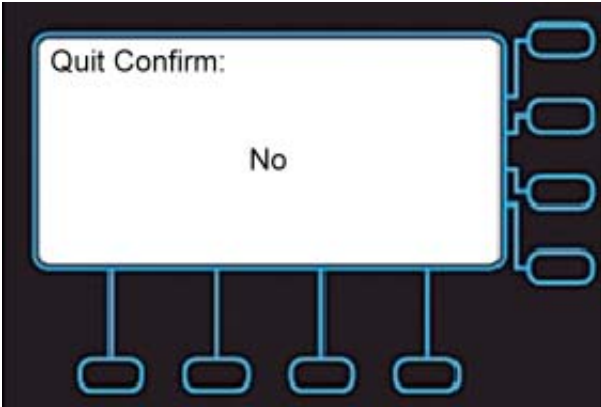

You will exit the screen and can continue to configure your phone.

2.2. Configuring Basic Settings

2.2.1. Volume Setting

You can configure following volume settings:

- Ring Volume
- Handset Speaker
- Hands-free Speaker
- Headset Speaker
- Handset MIC
- Hands-free MIC
- Headset MIC

To configure volume:

1. Press "**Menu**".
2. Select **Phone Setting > Volume Setting**. And select which device volume you want to set.
3. Select from Ring Volume, Handset Speaker, Hands-free Speaker, Headset Speaker, Handset MIC, Hands-free MIC, Headset MIC.

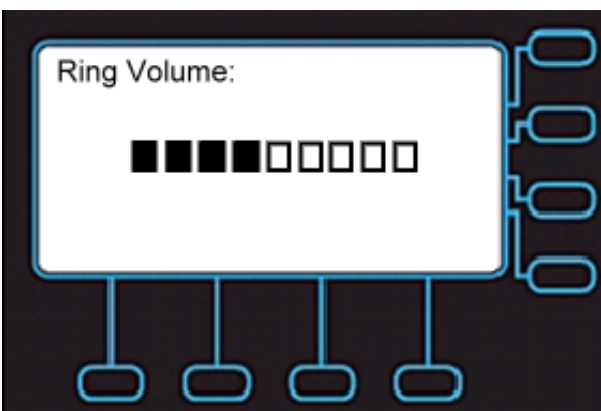

4. Use the **Navigation Up** and **Down** or **Volume Up** and **Down** keys to change the volume levels.
5. Press the **Navigation OK** key to confirm the change and exit volume change screen.

2.2.2. LCD Brightness

To configure the brightness of the LCD to a comfortable level:

1. Press **“Menu”**.
2. Select Phone Setting > Backlight > Brightness.
3. Press **Navigation Up** and **Down** keys to increase or decrease the display brightness.
4. Press the **Navigation OK** key to confirm the changes and exit the menu.

2.2.3. LCD Contrast

To configure the contrast of the LCD to a comfortable level:

1. Press **“Menu”**.
2. Select Phone Setting > Contrast.
3. Press **Navigation UP** and **Navigation Down** keys to increase or decrease the display contrast.
4. Press **Navigation OK** key to confirm the changes and exit the menu.

2.2.4. Call Setting

You can configure following call features:

- Do Not Disturb (DND)
- Auto Answer
- Call Waiting

To configure those features:

1. Press **“Menu”**.
2. Select the **Phone Setting > Call Setting**: then select which feature you want to change.
3. Select from **DND, Auto Answer, or Call Waiting**. Following screen is DND setting screen.

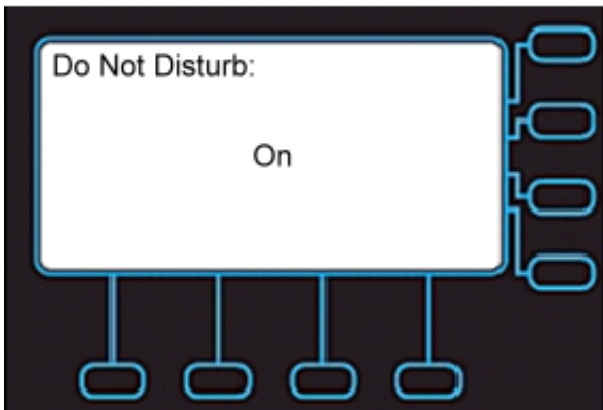

4. Use the **Navigation Up** and **Down** keys to select **On** or **Off**.
5. Press the **Navigation OK** key to confirm the changes and exit the menu.

2.2.5. Lock Your Phone

Sometimes you don't want other people to use your IP Phone. You can lock your phone and configure a personal identification key (PIN) to unlock the phone.

To lock your phone:

1. Press **“Menu”**.
2. Select **Phone Setting > Phone Lock**.
3. Press the **Navigation Up** and **Down** keys to select **On** or **Off**.
4. Press **Navigation OK** key to confirm the change and exit the menu.
5. You will see your phone is locked.

Following is a locked phone screen.

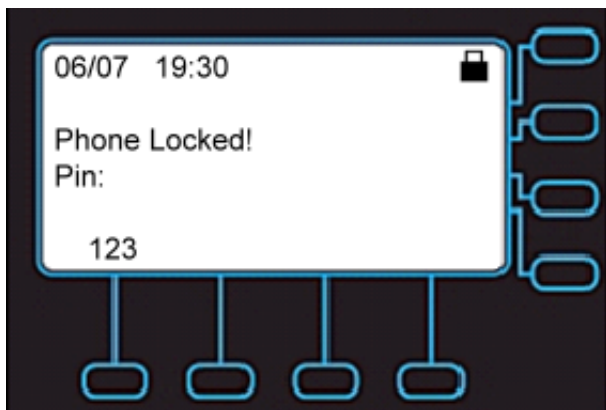

2.2.6. Speed Dialing Setting

The Speed Dialing feature let you store up to 10 phone numbers that you can access easily using a single digit Speed Dial number from 0 to 9.

To configure a speed dial number:

1. Press the **“Spd”** soft-key below the LCD screen, or Press **Menu > Phone Setting > Speed Dialing**.
2. Select the speed dial number to configure (from 0 to 9). And press the **Navigation OK** or **“Edit”** soft-key to edit the setting, and enter the phone number.
3. Press the **Navigation OK** key to confirm the changes and exit the menu.

2.2.7. Reboot Your phone

Sometimes you will need to reboot your phone to apply new settings.

To reboot your phone:

1. Press **“Menu”**.
2. Use the **Navigation Up** and **Down** keys to select **Reboot**.
3. Press **Navigation OK** to reboot your phone. Phone will show a **“Reboot”** message and the phone will restart.

Note: the IP3062 takes about 2 minutes to startup after rebooting; there will be a series of diagnostic lights on the phone during the process. If your phone does not become operational within 2 minutes, contact your administrator or Service Provider support line.

2.3. Managing Contacts

The IP3062 supports four different contact lists:

- All Contacts

- LDAP Directory
- Public Contacts
- Private Contacts

You can store up to 100 **Private Contacts** in your phone's directory, and you can add, edit, delete, dial, or search for a contact in this directory.

Public Contacts are provided for you by the administrator or Service Provider. They can be viewed, and used, but not changed or deleted. For more information, please contact your administrator or Service Provider.

The IP3062 can also access a local or remote **LDAP Directory**. Please contact your administrator or Service Provider for more information on how to enable, configure or access this feature.

The **All Contacts** lets you search and dial a contact from all the configured contacts databases.

There are three ways to enter your phone's directory:

- Press the "**Phonebook**" hot key.
- Press "**Dir**" soft-key.
- Navigate to **Menu > Phone Setting > Phonebook**.

2.3.1. Adding Contacts

To add a new contact:

1. Go to the **Phonebook > Private**.
2. Press the "**Add**" soft-key.
3. Enter "**Name**", "**Number**", and "**Ring type**", from the key pad.

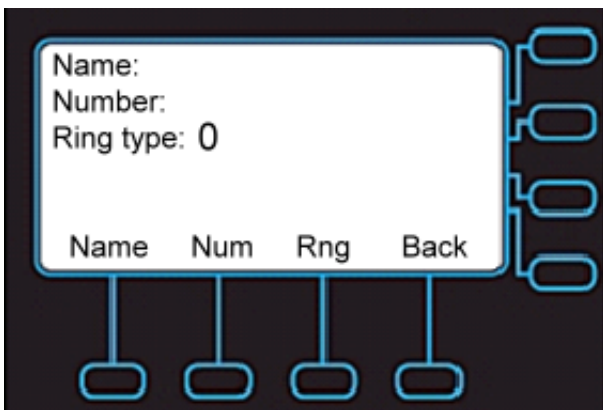

4. Press the "**Save**" soft-key when you are finished.

2.3.2. Editing Contacts

To edit your contact:

1. Use the **Navigation Up** and **Down** keys to select the contact your want to edit.
2. Press the "**Edit**" soft-key.
3. Use the **Navigation Up** and **Down** keys to select the fields you want to change.
4. When finished making changes, press the "**Save**" soft-key to save the changes.

2.3.3. Deleting Contacts

To delete your contact:

1. Use the **Navigation Up** and **Down** keys to select the contact your want to delete.
2. Press “**Del**” soft-key.
3. The contact is deleted from the directory.

2.3.4. Searching for a Contact

To search for a particular contact:

1. Go to **Phonebook > Private**.
2. Press the “**Search**” soft-key.
3. Input the first character of the contact’s name and the IP3062 will move to the first contact matching the character.
4. Using the **Navigation Up** and **Down** keys, choose the desired contact.

2.3.5. Placing a Call to a Contact

To dial from a directory:

1. Navigate to a contact (private, public or LDAP).
2. Press the “**Dial**” soft-key.
3. The phone will dial the number selected.

2.4. Managing Call Logs

In the IP3062, there are three call log types:

- Dialed Calls
- Missed Calls
- Answered Calls

The call logs save the last 30 numbers dialed, missed or answered. For example, the following is the Dialed Calls list screen.

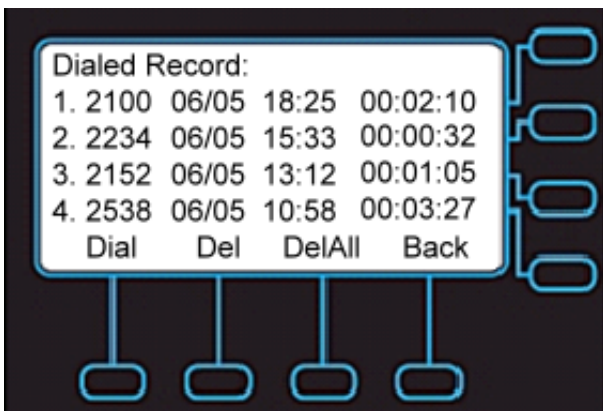

From the call log lists, you can view, delete, and dial.

To manage the selected call log:

- Use the **Dial** soft-key to redial the call.
- Use the **Del** soft-key to delete the selected item.

- Use the **DelAll** soft-key to delete all items in the list.
- Use the **Back** soft-key to exit the call list screen.

2.5. Viewing Your Phone's Information

Using the menu of the IP3062, you can check the IP3062 hardware version, firmware version, and network status.

To view this information:

1. Press the **"Menu"**.
2. Select **"Information"**.
3. Use the **Navigation Up** and **Down** keys to view the information.

2.6. Configuring An Extended Dial Module (EDM) Setting

The IP3062 supports the connection of up to two 24 button extended dial modules (EDM) for a total of 64 programmable buttons on a phone. The buttons can be used for monitoring other phone extensions with busy lamp field (BLF) notification, speed dials numbers and system features such as overhead paging, park and pickup. The EDM is connected to the IP3062 with a small cable, making it very convenient to add and program extra buttons as needed.



There are 24 buttons on an EDM. Each button can be programmed for speed dial numbers, phone system features like park, pickup and paging, or to monitor other extensions using busy lamp field (BLF) notifications.

To configure an EDM key:

1. Press **"Menu"**.
2. Select **"EDM Setting"**.
3. Select an **EDM** (from 1 to 2) to set.

And then select a **key** (from **Key 1** to **Key 24**), for each key, you can set **Function type**, **Function Number** and **Line Supported**.

2.7. Configuring Programmable Keys

The IP3062 has 16 programmable keys, which can be configured for speed dial numbers, phone system features like park, pickup and paging, or to monitor other extensions using busy lamp field (BLF) notifications. From the Menu, you can view the settings for each key.

To see the setting status:

1. Press **“Menu”**.
2. Select the **“Program Key”**.
3. Select the **FUNC#1-FUNC#16** to see their settings.

2.8. Managing Voice Mail

Some hosted SIP services and IP PBXs provide a message waiting indicator (MWI) to alert you to any new voicemail on your phone. Your phone can receive MWI information from supported services and servers.

To view your voice mail status:

1. Press **“Menu”**.
2. Select **“Voice Mail”**.
3. You can see the voice mail count for your accounts.

To get more information on MWI status:

1. Press **Menu > Voice Mail**.
2. Select the account you want to check and press the **Navigation OK** key.

2.9. Managing Instant Message

The IP3062 supports SIP SIMPLE Instant Messaging (IM). With a supported service or server, such as Ondo, Partysip, Asterisk (in-session mode), and any SIP proxy or PBX that can forward SIP MESSAGE requests, you can send and receive messages right from your phone using the on-screen dialpad; there is also a way to configure some useful Message Templates, which are pre-made messages for common requests or responses, to simplify use of IM on the IP3062. In addition, you can attach a supported USB keyboard to the IP3062 to use the IM features

There is a message icon and a popup message on the LCD screen when there is a new message received.

To view the messages, you can:

1. Press the **Navigation OK** key.
2. The messages are listed for you to view.

Or

1. Press **“Menu”**.
2. Select **Message > Instant Messaging > Simple > Inbox**.
3. The messages are listed for you to view.

To create a new message:

1. Press **"Menu"**.
2. Select **Message > Instant Messaging > Simple > New Message**.
3. Enter **"To"**, **"From"**, and **"Msg"**, from the key pad.

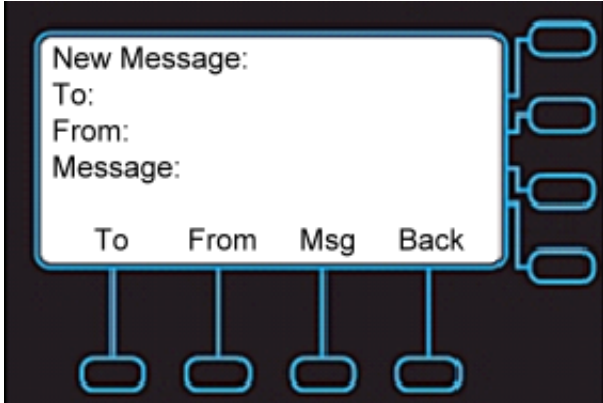

To delete a message:

1. Press **"Menu"**.
2. Select **Message > Instant Message > Simple > Delete Messages**.
3. Select what data you want to delete, you can select **Delete Inbox Messages**, **Delete Outbox Messages** or **Delete All Messages**.

To edit a Message Template:

1. Press **"Menu"**.
2. Select **Message > Instant Message > Simple > Templates**.

The IP3062 can save and use up to 30 Message Templates.

2.10. Viewing Notifications

The IP3062 supports Broadsoft Server Notifications. With this feature, administrators or service providers can send messages to users connected to a Broadsoft server. For more information, please contact your administrator or Service Provider.

3. Using Basic Features

The IP3062 Professional IP Phone is designed to be used like a regular phone on a public switched telephone network (PSTN). You can place calls, transfer a call to someone else, or conduct a conference call.

The IP3062 supports up to four simultaneous calls. However, only one of these calls can be active at a time. The active call is the one you are using to speak or listen to. The inactive calls can be:

- On hold
- Joined in a conference (with up to five callers)
- “Incoming call” or “Ringing”

This chapter provides basic operating instructions for the phone including:

- Placing a Call
- Placing an Urgent Call
- Answering a Call
- Answering an Urgent Call
- Ending a Call
- Redialing a Number
- Putting a Call on Hold
- Setting Up a Conference
- Transferring a Call
- Forwarding Calls
- Enabling or Disabling Do Not Disturb

3.1. Common Terms

To use the IP3062, you need to follow some conventions that we will mention in this guide. In the following descriptions, we will introduce some common terms for your understanding.

3.1.1. Lines

A “Line” in this guide represents how many phone numbers supported in one phone. For example, the IP3062 can support up to four lines configured for the same or different service providers or servers and even make up to four concurrent calls. Therefore, the IP3062 is said to support **multiple line appearances**.

3.1.2. Calls

A “Call” in this guide represents how many simultaneous connections can be made to a single phone number. Each line of service in the IP3062 can support up to four calls simultaneously. This allows the user to place one caller on hold and talk to the other person in another call on the same Line. Therefore, the IP3062 phone is said to support **multiple call appearances**.

3.1.3. Registration

The IP3062 must be configured before it can perform some basic functions. Although the phone can make a peer-to-peer SIP call by dialing the other user’s IP address (i.e.,

192.168.0.12) directly on the keypad, this is inconvenient and it is hard to remember all the IP addresses of phones on the system. This is why a hosted SIP server or local IP PBX implements a Registrar service, which allows the connected phones to find and dial each other more easily by extension numbers or names instead of IP addresses.

In addition, the hosted SIP server or IP PBX helps keep track of active phones, their IP addresses for routing calls, as well as keeping track of which phones are busy or idle. Most hosted SIP services and IP PBXs support direct system service (DSS) as well as showing the busy lamp field (BLF) status of system phones. These allow you to directly dial another extension and can show you whether the other phone is on a call or not.

Usually, the hosted SIP service or IP PBX will also use the Registrar service to send messages to your phone to alert you that you have voicemail. This is called message waiting indication (MWI).

3.1.4. Caller ID

When you receive a call, the caller's phone number is shown on the screen, if the caller has not chosen to hide his number and if the network supports the Caller ID feature. The IP Phone can display both the Caller ID (CLID) and the Caller Name (CNAM) of the caller if it is available. Not all services and servers support CLID and CNAM. For more information about this topic, please contact your service provider or system administrator.

3.2. Installing Your IP Phone

Before placing the phone into operation, either you or your administrator or Service Provider has to install the phone on your network. Please contact your administrator or Service Provider for more details.

3.3. Configuring Your IP Phone for Service

The IP3062 must be configured for the hosted SIP service or IP PBX before operation. The phone is usually pre-configured by the administrator or hosted SIP service provider. For an advanced or experienced user, you may refer to the [IP3062 Administrator Guide](#) for full information on how to configure all the settings of the IP3062.

3.4. Line Selection

The IP3062 can support up to 4 lines.

To select a line you can:

Use the preferred line setting. That means when you pick up handset, or press the speakerphone key, or press headset key when not on a call, the phone will automatically use the preferred line for the call. If the preferred line is not the line



you want to use, you can press **Line Key** buttons () on the right hand side of the LCD to switch to the desired line.

Press the **Line Key** buttons () , which will connect to the chosen line.

3.5.Placing a Call





You can place a call in many ways from the IP3062:

- Using the handset
- Using the speakerphone
- Using the headset
- Pressing a line key

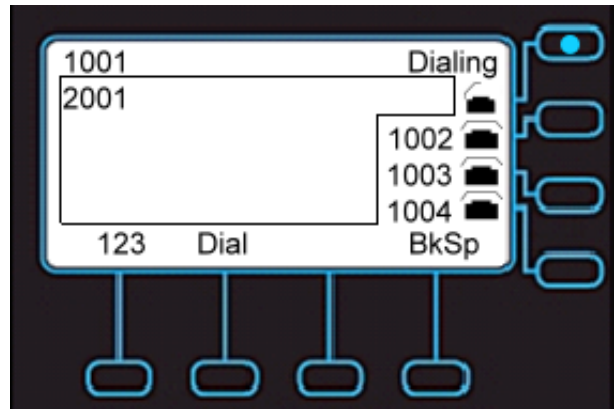
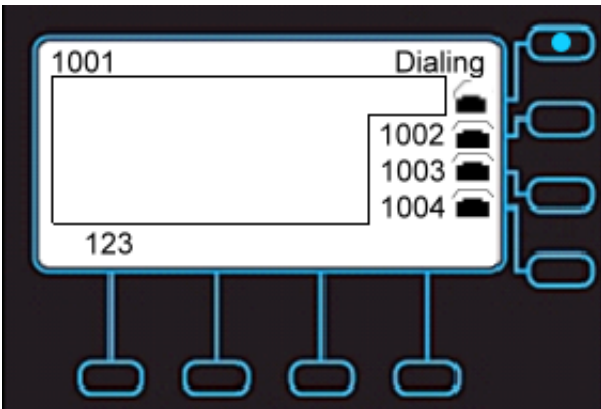
You can also dial the number first and then choose the method you will use to dial the other party. This is called pre-dialing. During a call, you can alternate between using the handset, headset or speakerphone modes by pressing the speakerphone key() , the headset key() or picking up the handset while on a speakerphone call. The call duration on an active call is shown on the LCD during the call.

To place a new call:



Operation	Description	
Making a call	 or  or   Line Key	1. Pick-up the handset or press a line key or press the speakerphone key or press the headset key. → You will hear a dial tone.
		2. Use the keypad to dial the phone number. → The LCD window displays the number you enter. Note: You may use the “BkSp” soft-key to delete the last digit.
		3. On-hook the handset when your conversation is over.

3.6.Placing an Urgent Call

The IP3062 supports Broadsoft’s Urgent Call feature. Please refer to the **Section 4.4. Changing Phone Settings** for more information on configuration of this feature.

If your IP phone is enabled for “Urgent Call”, when you dial a number, there is an “Urgnt” softkey displayed on the LCD screen.

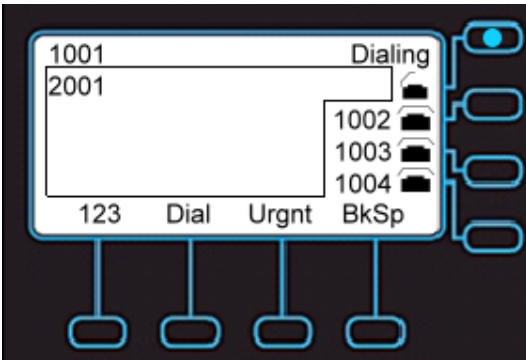

If you press the “Urgnt” softkey to dial the number out, the call will be marked as an urgent call. The called party can neither deny nor block the call even the called party’s phone is on DND.

3.7. Adjusting Call Volume

During a conversation, if the voice volume is too low or too high, you may adjust it.

To adjust volume while on a call:

Operation	Description
Adjusting Call Volume	Press the Volume control key to adjust the volume.

3.8. Canceling a Call

After you dial a call, but the called party has not answered, you can Cancel the call.

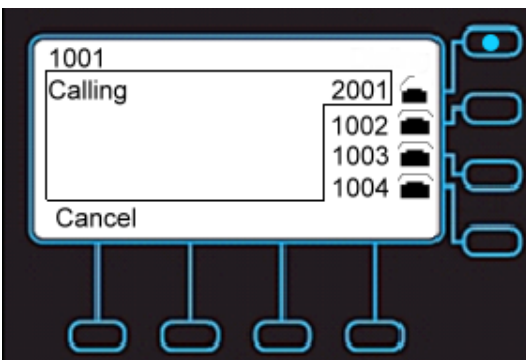

Operation	Description	
Canceling a call	Cancel	Press “Cancel” soft-key to reject the call. <i>If only the calling call on the phone, you can just press speakerphone or put down handset to cancel the call.</i>

3.9. Answering a Call

When there is a new incoming call on the phone, you can answer a call by:

- Using the handset
- Using the speakerphone
- Using a headset
- Pressing “**Ans**” soft-key

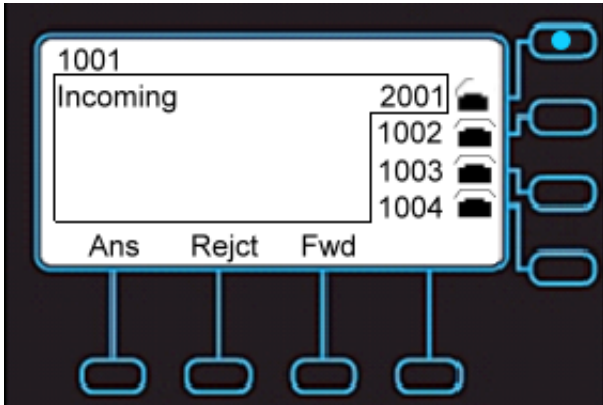

<i>Operation</i>	<i>Description</i>	
Answering a call		<p>If there is no other call, just pick-up the handset or press the speakerphone key or the headset key or press the “Answer” soft-key upon hearing the phone ringing.</p> <p>If there is another call, press “Answer” soft-key to accept the call, the previous call will be placed on hold automatically.</p>

3.10. Answering an Urgent Call

When there is an incoming urgent call on the phone, you can answer a call as you would normally; however, some features will be ignored automatically including DND and call blocking.

3.11. Rejecting a Call

When there is an incoming call on the phone, you can reject the call.

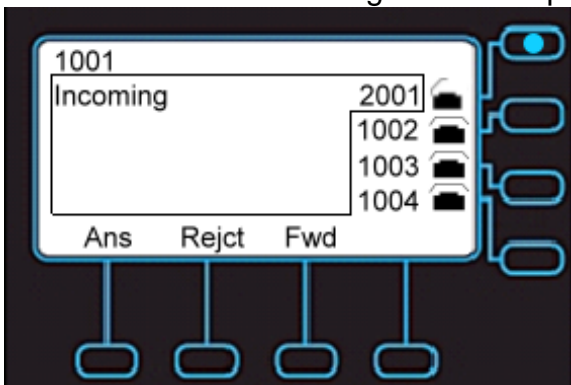





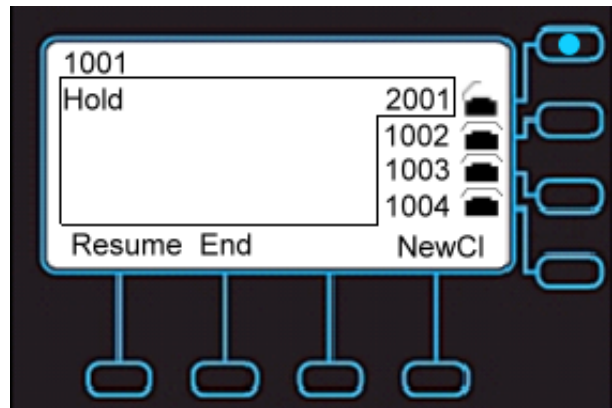
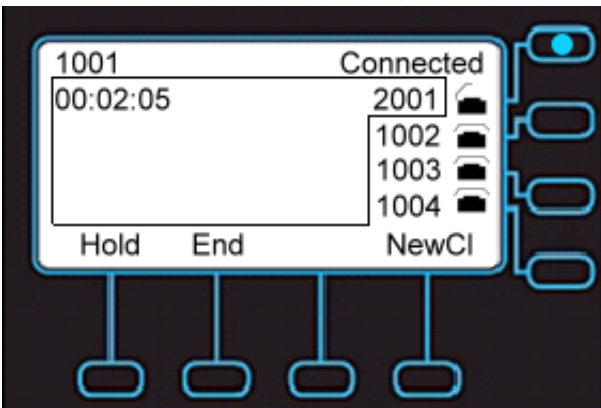

Operation	Description	
Rejecting a call	Reject	<p>Press “Reject” soft-key to reject the call.</p> <p><i>After pressing the “Reject” soft-key, the call will be dropped directly. The record will be logged in answered call list. Other call features are not affected by this operation.</i></p>

3.12. Ending and Holding and Resuming a Call

When a call is in connected state, you can end a call by:

- Using the handset
- Using the speakerphone
- Using a headset
- Pressing “**EndCall**” soft-key



Operation	Description	
Ending a call	 or  or  or End	<p>If there is only one call, just place the handset back into the cradle, press the speakerphone key or the headset key or press “End” soft-key to end the call.</p> <p>If there is another call, press the “End” soft-key to end the call.</p>
Holding a call	 or Hold	<p>Press the “Hold” soft-key or Hold key on the phone to place an active call on hold.</p>
Resuming a call	 or Resume	<p>Press the “Resume” soft-key or Hold key on the phone again to place an active call on hold.</p>

3.13. Muting and Un-muting a Call

While in a conversation, you may mute the microphone by pressing the **MUTE** () button. The LED of the button will become blue. When muted, the other caller will not hear anything from your phone.

Pressing the **MUTE** () key again will Un-mute the phone.

3.14. Redialing a Number

To redial the last numbers you dialed:

1. Press **Redial** () hot key.
2. Phone will enter “**Dialed Record**” list.
3. Select the number you want to redial.
4. Press “**Dial**” soft-key to dial out.

For more information, please see **2.4. Managing Call Logs**.

3.15. Setting up a Conference Call

The IP3062 can support a 5-party conference call .

To set up a conference:

1. Call the first party and Hold the call.
2. Press “**NewCI**” soft-key to call another party
3. Press the **Conference** () hot key to set up a 3-party conference call.

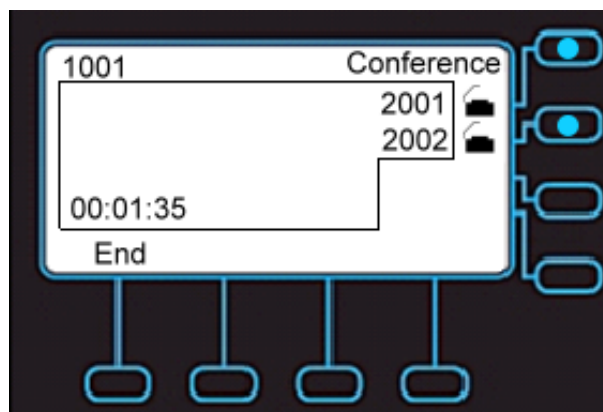
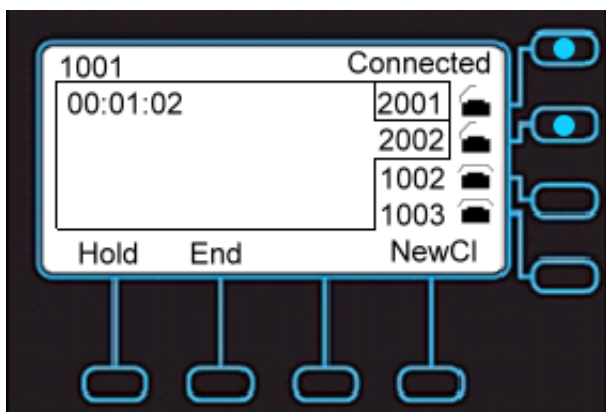

Note, here is a 3-party conference call, if you want to set up a 4-party or a 5-party conference call, repeat Step2 to dial third or fourth call, and then do Step3.

3.16. Transferring a Call

A call can be transferred in one of three ways:

Blind Transfer: The call is automatically transferred after you dial the number of the party to whom you want to transfer the call.

Semi-Attended transfer: The party to whom you want to transfer the call does not answer their phone before you transfer the call (when you hear ring-back tone).

Attended transfer: The party to whom you want to transfer the call answers their phone before you transfer the call. You can consult with them before completing the transfer.

3.16.1. Blind Transfer

To complete a blind transfer:

1. During an active call, press the **Transfer** () hot key.
2. The active call is placed on hold, and an entry screen is displayed for the number you want to transfer to.
3. Press **Navigation OK** or “**Dial**” soft-key to complete the transfer. If you want to
4. cancel transfer operation, just press the “**Back**” soft-key.

3.16.2. Semi-Attended Transfer

To do Semi-Attended transfer:

1. During an active call, press “**NewCl**” soft-key to call another party.
2. When you hear the ring-back tone, press the **Transfer** () hot key.

3.16.3. Attended Transfer

To do Attendant transfer:

1. During an active call, press “**NewCl**” soft-key to call another party.
2. Wait for the other party to answer the call.
3. Press the **Transfer** () hot key.

Note: sometimes, you may place more than 2 calls on your phone, when you press **Transfer** () hot key, phone will show a call list to let you select a call to finish the transfer operation.

3.17. Forwarding a Call

You can configure your phone to forward your incoming call to another party, which is sometimes called as static forwarding. You can also dynamically forward calls while your phone is ringing.

There are three types of static forwarding:

- Unconditional
- No answer
- Busy

For more information on how to setup static call forwarding, please contact your administrator or Service Provider support center.

To use dynamic forwarding:

1. When the phone rings with an incoming call, press the “**Fwd**” soft-key.
2. Enter a number to forward the incoming call to.
3. Press **OK** soft-key to forward the call.

3.18. Using Voice Mail

Your voicemail is saved on either your hosted SIP service or on the IP PBX, but you can access it from the IP3062 using the **Message** key.

The presence of new voice mail messages is indicated by a flashing message waiting indicator (MWI) LED on the front of the phone and an icon is shown on LCD.

Note: Voicemail is an optional feature configured on a hosted SIP service or IP PBX and may not be supported on your particular system. To use voicemail on the IP3062, some settings need to be configured first. For more information please contact your administrator or Service Provider support center.

To listen your voice messages:

1. Press the **Message** () hot key to display the mailbox list.
2. Select which SIP line's mailbox you want to listen to and press "OK".
3. A call will be placed to your voice mail server.
4. Follow the interactive voice response (IVR) instructions to retrieve and listen, forward or delete your messages.

3.19.Placing a Speed Dial Call

To configure a speed dial number, please see **2.2.6 Speed Dialing Setting**.

To make a speed dial call:

1. Pickup the handset, or press a line key, or press the speaker key or press the headset key.
2. When you hear dial tone, dial the one digit (0-9) speed dial key you previously configured.
3. Press "OK" or the "Dial" soft-key and the phone will look up the key in the speed dial table, find the matching item and dial the number assigned to the speed dial key.

3.20.Using Multiple Lines

IP3062 can support up to four lines configured for the same or different service providers or servers. It allows you to make up to four concurrent calls.

For example, the following screen shows you line1001 has one active call with number2001.

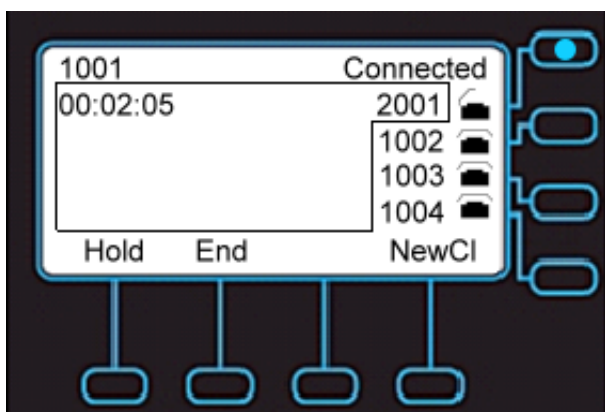

You can make a new call by using another line, 1002. Press the **Line Key** button, 1002, on the right hand side of the LCD, and then make a call to number 2002.

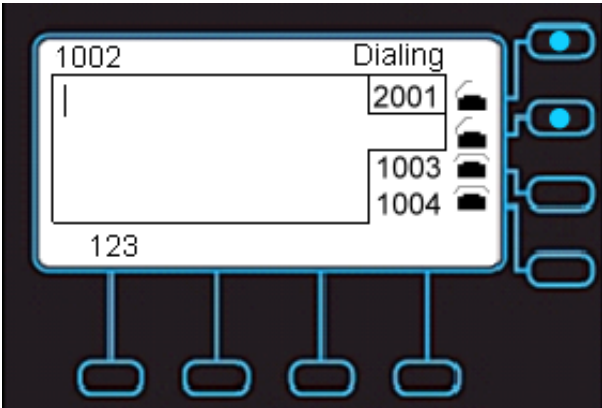

After the called party answers the call, the following screen shows you line1001 has one held call with number2001, and line1002 has one active call with number2002.

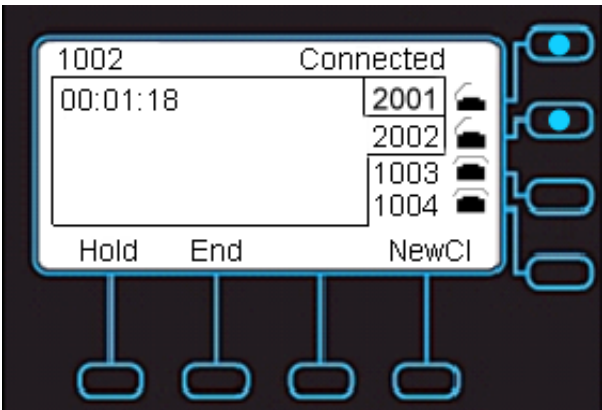

To switch between the two calls, press **Hold** soft-key to hold the line1002 which calls to number2002 first. Then press the **Line Key** button, 1001, on the right hand side of the LCD, which calls to number2001 to unhold the call.

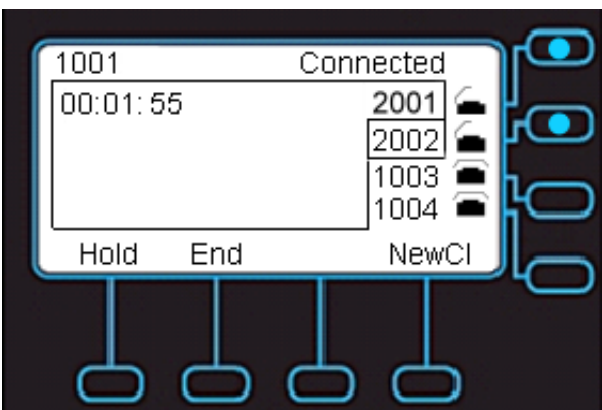

By the steps as above, you can make up to four concurrent calls.

3.21.Using Multiple Calls

Each line of service in the IP3062 can support up to four calls simultaneously. It allows you to place one caller on hold and talk to the other person in another call on the same line.

For example, the following screen shows you line1001 has one active call with number2001.

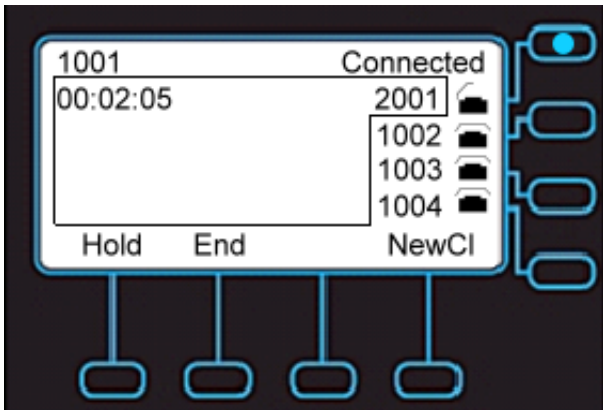

You can make a new call on the same line, just press **NewCI** soft-key to call another party.

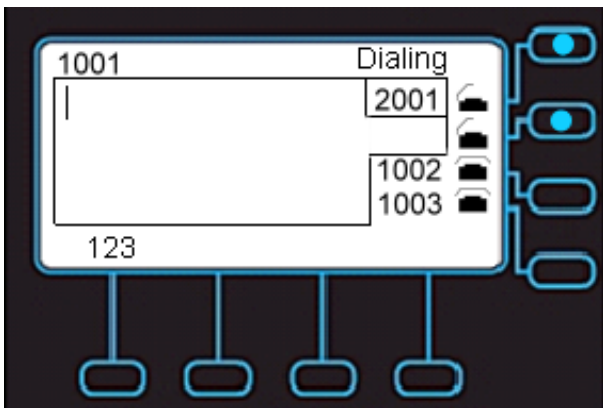

After the called party answers the call, the following screen shows you line1001 has two calls, the call to number2001 is on hold, and the call to number 2002 is active.

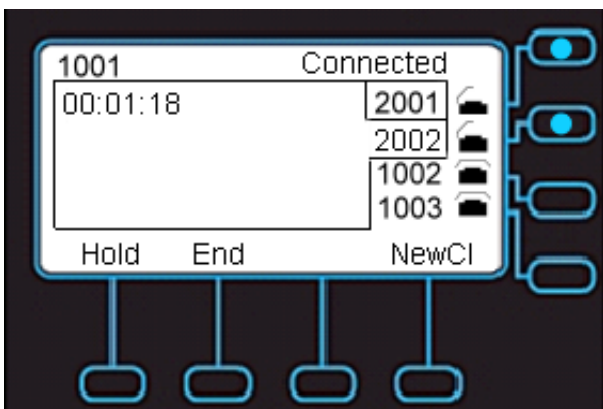

By the steps as above, you can use one line to make 4 calls simultaneously.

4. Using Advanced Features

The **Getting Started** chapter describes the steps used to customize the IP3062 from the LCD menu of the phone. However, there are many advanced features that need to be configured using the phone's web user interface. This chapter provides instructions on how to use these features.

4.1. Login Web UI

To use your web browser to configure the IP3062, you need to know the IP address of the phone on your local area network (LAN). Using the LCD menu, find the IP address of the phone under **Menu > Information > IP Address**.

1. Point your web browser to the IP address of the IP3062.

Enter the correct Username and Password information into the dialog box and press OK.



Note: The default Username is “user” and the default Password is “1111” and the default network settings are:

Default IP address: **192.168.1.10**
Default Subnet mask: **255.255.255.0**
Default Gateway: **192.168.1.1**
Default DNS: **8.8.8.8**

4.2. Changing the User's Password

Some features of the IP3062 require you to enter a personal identification number (PIN) for security. The default PIN of the IP3062 User account is “1111”.

To change the User password:

1. Navigate to the **System** tab.
2. Locate User Settings > User Password:.
3. Change the password to use a new PIN.

4.3. Viewing Phone Information on Web User Interface

Information is the first page you will see when you login to the phone's web user interface. This page lets you check the status of the IP Phone including network and product related information as well as account status information.

Network Information	
Network Type:	DHCP
Subnet Mask:	255.255.255.0
Primary DNS:	10.10.10.1
Link Mode:	Wire
Current IP:	10.10.10.16
Default Gateway:	10.10.10.1
Secondary DNS:	
Product Information	
Product Name:	IP3062
Firmware Version:	IP3062_F_5_3_2012-05-28
SN:	xxxxxxxx
MAC Address:	00:19:15:9B:CC:F5
Application Version:	F_5_3_1.0.25
Hardware Version:	IP3062_PR
Line 1 Status	
Phone Number:	3916
SIP Proxy Server:	60.250.158.234
Registration State:	Registered
Line 2 Status	
Phone Number:	3917
SIP Proxy Server:	60.250.158.234
Registration State:	Registered

For SIP Line status:

- When this line is disabled, the line status will not be displayed.
- “Registration State” will be marked “Registered” with green text.
- “Unregistered” will be marked with red text.

4.4. Configuring Phone Settings

Phone Settings enables you to configure private settings for phone. Select the **Phone** tab of the web user interface to begin configuration.

From this page you can change following settings:

- Device Volume
- Tone and Ring types
- Voice parameters
- Advanced phone features (DND, Auto-answer, Call Waiting, etc)
- Speed dial settings
- Programmable key settings

Here is the description of each field.

<i>Field Name</i>	<i>Function</i>
-------------------	-----------------

Handset Mic	Set the input level of handset microphone.
Handset Speaker	Set the output level of handset speaker.
Handfree Mic	Set the input level of hand-free microphone.
Handfree Speaker	Set the output level of hand-free speaker.
Headset Mic	Set the input level of headset microphone.
Headset Speaker	Set the output level of headset speaker.
Ring Volume	Set the output level of ring.
Tone Type	Select the tone type. There are 11 types of standard Tone for selection.
Ring Type	Select the ring type. There are 11 types of standard Ring for selection.
Sidetone	Set the output level of side tone.
Preferred Line	Select the SIP line automatically to dial out if not press SIP line manually when dialing.
Enable Music on Hold	Plays hold music on phone when held by remote.
Enable Auto Answer	Turn on auto answer function.
Enable DND	Turn on DND function, block any incoming all
Enable Call Waiting	Turn on call waiting function.
Enable Call Waiting Tone	Play call waiting tone when there's another incoming call.
Enable Hold Reminder	Turn on the Hold Reminder function.
Hold Reminder Time (sec)	Set the time (10~60 sec) that phone will remind user with a tone when the call hold remote every this time period.
Hotline Number	Set the hotline number
Hotline Timeout(sec)	Set the time (1~60 sec) when phone off hook but not dial, phone will dial out the hotline number automatically after this time period.
Dial Timeout (sec)	Set the time (1~30 sec) that phone will dial out automatically after this time period.
Enable Phone Lock	Lock the phone.
Enable Urgent Call	Enable Urgent Call to add urgent call option in dialing screen.
Phone Number Display style	Set the display style for calling name and number.
RTP Port Base	Set phone local RTP Base Port.
Speed Dialing Entry 0~9	There are 10 speed dial entries for user to store. Each entry map to the numeric keypad on the IP Phone.

Programmable Key Setting 1~16	Please refer to the section 4.5. Managing programmable keys.
--------------------------------------	--------------------------------------------------------------

4.5. Managing Programmable Keys

Your IP3062 Phone has 16 programmable keys which can be configured for different features.

To use the programmable keys, just press the key, then the configured feature will be executed, some features will blink the LEDs or turn on the related features.

To configure programmable keys, go to **Phone** tab of the web user interface, and find the **“Programmable Key Settings”** section:

<i>Option Name</i>	<i>Function</i>
Do Not Disturb	Enable/disable DND feature.
Lock IP-Phone	Lock your phone.
Speed Dial	Speed dial configured numbers.
Abbreviated Codes	Speed dial the codes.
Busy Forward	Set static forwarding number when busy.
Always Forward	Set static forwarding number unconditional.
No answer forward	Set static forwarding number when no answer.
DND Forward	Set forwarding number when DND feature is enabled.
Auto Answer	Enable/disable auto-answer feature.
Caller Blocking	Set a caller blocking item.
BLF	Set number for Busy lamp field feature. Contact administrator for help.
Call Park	Set call park number, PBX related feature. Contact administrator for help.
SLA	Set SLA number. PBX related feature. Contact administrator for help.
Asterisk Parking Number	Set Asterisk Park number, PBX related feature. Contact administrator for help.
Asterisk Parking Slot	Set Asterisk Park Slot number, PBX related feature. Contact administrator for help.
Intercom	Set Intercom number, PBX related feature. Contact administrator for help.

Feature Code	Set speed dial for feature codes.
DTMF	Set DTMFs for call.
Save Settings	Save changes in this page to the phone.
Cancel	Discard all changes in this page.

4.6. Configuring SIP Line Settings

On the **SIP** tab of the web user interface, you can change various SIP settings for each Line.

A user can block specific calls by Caller ID (CLID). For each SIP Line, you can configure up to 10 blocking entries.

Field Name	Function
Always Call Forwarding	Enable/disable always call forwarding.
Busy Call Forwarding	Enable/disable busy call forwarding.
No-Answer Call Forwarding	Enable/disable no-answer call forwarding.
DND Call Forwarding	Enable/disable DND call forwarding.
No Answer Timeout	Set no answer timeout time (seconds).
Always Forward Destination	Set always forward number.
Busy Forward Destination	Set busy forward number.
No-Answer Forward Destination	Set no answer forward number.
DND Forward Destination	Set DND forward number.
Enable Block Anonymous Call	Enable/disable block anonymous call feature.
Caller Blocking Entry 0~9	Set caller blocking numbers.
Save Settings	Save changes in this page to the phone.
Cancel	Discard all changes in this page.

4.7. Configuring System Settings

On the **System** tab, the user can access or change:

- Password
- Time settings
- Debug logs
- Reboot the phone

Field Name	Function
User Name	The user username. It is fixed, and can't be changed.
User Password	The user password
Auto DST	Enable Automatic daylight saving time flag
Daylight Saving Time	Set daylight saving time, -1, 0, +1, according to your location
Starts on	Set DST start Month, Day, Time
Starts end	Set DST end Month, Day, Time
Time Format	Set LCD date/time display modes
Time Zone	Set Phone Time Zone.
System Log Download	Click to download System Log
SIP Log Download	Click to download SIP Log
Reboot	Click to reboot IP Phone
Save Settings	Save changes in this page to the phone.
Cancel	Discard all changes in this page.

4.8. Managing EDM

On the **EDM** tab, the user can configure 24 programable keys of each EDM. For the details of setting options, please refer to the **section 4.5. Managing Programmable Keys**.

4.9. Managing Phonebook

On the **Phonebook** tab, the user can manage his phone directories.

4.9.1. Private Phonebook

For the Private Phonebook, the user can add, edit, delete or dial an entry directly from the web page. The user can also upload his contacts from a file using a web browser. The Private Phonebook can have up to 100 contacts.

4.9.2. Public Phonebook

For the Public Phonebook, a user or administrator can upload a file using a web browser.

4.9.3. LDAP Directory

The LDAP Directory can be configured using a web browser; please contact your administrator or Service Provider support desk for more information.

Field Name	Function
Number Guessing Option	Set number guessing feature data source.
LDAP Security	Set LDAP security type, SSL2, SSL3 or TLSv1.

LDAP Server Address	Set LDAP server address.
LDAP Server Port	Set LDAP Server port.
LDAP Login Name	Set LDAP user name.
LDAP Login Password	Set LDAP user password.
LDAP Base	Set LDAP Search Base.
LDAP Max. Hits	Set retrieve record counts from Server one time.
LDAP Name Filter	Set Name guessing filed in LDAP server.
LDAP Number Filter	Set Number guessing filed in LDAP server.
Test Configuration	Click to test if the LDAP server available. Show "Error" in red when unavailable, "Available" in green when available, "Not Configured" in black when hasn't set select LDAP.

4.10.Placing a Call from the Private Phonebook

There is a "Dial" button for each contact entry under Private Phonebook tab, you can press it and place a call to the contact.

A new window will show up when you click the "Dial" button,



If you click "Dial" to place the call, when the number dials out, the window will close.

4.11.Sending an Instant Message (IM)

On the **Phonebook** tab, the user can send instant messages.

To send an instant message:

1. Select a registered line that you want to use to send the IM.
2. Enter a text message.
3. Enter a contact's number.
4. Press "Send" button to send the instant message out.

5. Using Advanced Call Features

5.1. Centralized Conferencing (for Broadsoft PBX)

The IP3062 allows you to create multiple conferences with unlimited participants (depending on service or IP PBX limitations) when your Administrator enables Centralized Conferencing.

The steps to make centralized conferencing available are different for each supported IP PBX or hosted SIP service. On a Broadsoft softswitch, you can initiate a Server-based conference by pressing “Conf” soft key on LCD.

Note: the “Conf ” soft-key will show only you have set the “Conference Number” on SIP Web page.

To create a Conference:

1. Place some calls with the participants.
2. Press “**NewCal**” to enter dial screen, and a “**Conf**” soft-key will show up.
3. Press “**Conf**” soft-key and a conference will be created.
4. All participants are added to the conference automatically.

To add new participant to the conference:

1. Press “**NewCal**”, and dial the participant you want to add.
2. There will be a “**Conf**” soft-key when the call is answered by the other participant.
3. Press the “**Conf**” soft-key and the new participant will be added to the conference.

5.2. Call Waiting

The call waiting feature notifies the user on an active call of a new incoming call. You can disable the call waiting feature, so that the new incoming call is automatically rejected by the phone with a busy message.

If you disable call waiting on the phone, and the user is on a call, any further incoming calls receive busy unless “Call Forward Busy” is configured on the phone, where it then forwards the call according to the configured destination.

5.3. Intercom Call

5.3.1. Answering an Intercom Call

By default, the IP phone allows incoming intercom calls to be automatically answered on your phone. If the intercom call comes into the phone while an active call is already present, the phone puts the active call on hold and answers the intercom call.

5.3.2. Placing an Intercom Call

The Intercom call feature depends on PBX/SIP Server as there are different intercom call codes for each servers; for example, the Asterisk default intercom code is “*80”.

To place intercom call on an Asterisk server, just make a call to “*80”+ [destination number] (“*801001” for example). For other phone systems or hosted SIP services, please contact your administrator or Service Provider for more information.

6. Phone Firmware Upgrade

The IP3062 supports several different ways to update its firmware (please refer to the table below). This is for system administrators or service providers. End users normally do not have to upgrade firmware by themselves. Please contact your Administrator or service provider for assistance.

No.	Firmware Upgrade Method	Method Description	User	Admin.	Dist.
1	Upgrade using web browser on a specified computer	Download SW Update Pack from PC that Dual Kernel Image and Upgradable Applications are supported.	x	✓	✓
2	Upgrade from USB memory dongle*	Engineering keys sequence or LCM Menu command or Web action or Auto Detection.	✓	✓	✓
3	Auto-Provision upgrade with MOCET Auto-Provisioning System (APS)	Firmware upgrade via TFTP/HTTP/HTTPS mass provisioning by using MOCET APS protocol with encrypted XML configuration file.	x	✓	✓
4	Engineering key sequences on boot	1. Download complete flash image by U-boot at system reboot. 2. Download SW Update Pack from TFTP server. 3. Download SW Update Pack from USB dongle.	x	x	✓
5	Emergency Upgrade	Auto-detect (when the image checksum is wrong) and download complete flash image from TFTP server at fixed IP address.	x	x	✓

Note: Upgrade firmware from USB memory dongle needs to contact your distributor (or service provide) to acquire the USB memory dongle with the authorized firmware.

7. Using USB Devices with Your Phone

IP3062 can support different USB devices including USB keyboard, USB memory dongle* and USB Wi-Fi dongle.

7.1. USB Keyboard

When attaching a USB keyboard on your phone, there will be a USB keyboard icon on the LCD screen.

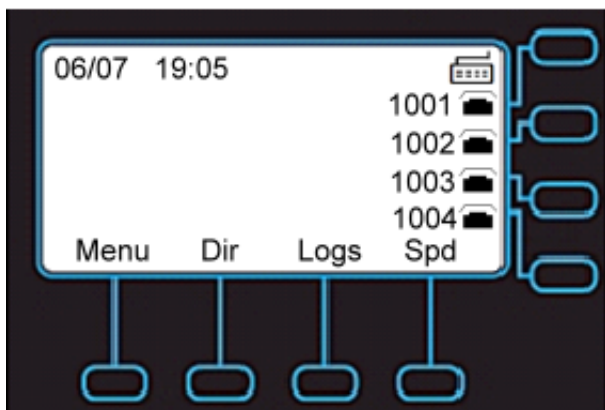

With USB keyboard, you can:

- Dial phone number
- Edit Phonebook
- Edit Speed Dial
- Edit Instant Message
- Edit Programmable Keys fields and EDM fields

7.2. USB Memory Dongle

When attaching an USB memory dongle on your phone, there will be a USB memory dongle icon on the LCD screen.

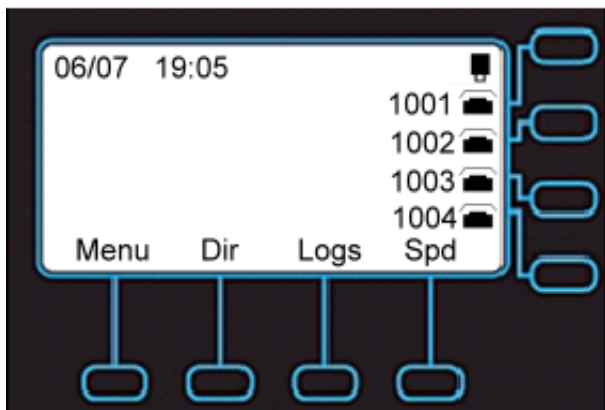

With USB memory dongle inserted in the IP3062, you can:

- Backup your phone's configuration file.
- Backup your private phonebook.

- Use .wav files for your Music-on-Hold (MoH), ringtones, and play recorded voice messages.
- Upgrade IP3062 phone firmware.

7.3. USB WLAN Dongle

To use a USB WLAN dongle with IP3062, you must use the supported model sold by MOCET.

When attaching a USB WLAN dongle on your phone, your phone will display an icon on the LCD screen.

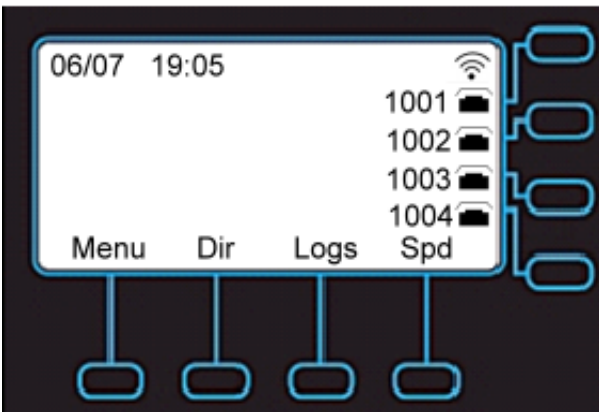

After connecting to a WLAN, your phone will display a WLAN signal strength icon on the screen.

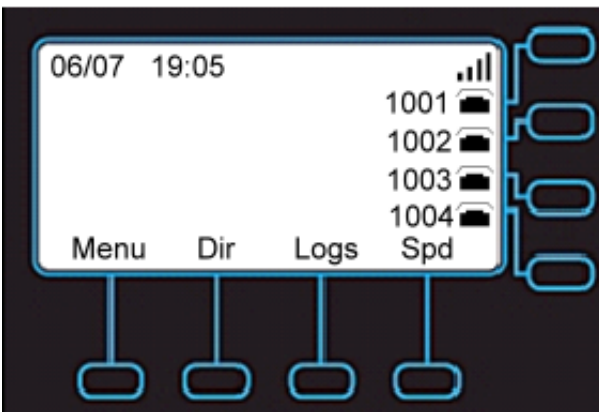

To configure the USB WLAN dongle, please contact your administrator or service provider for more information or assistance.

8. Troubleshooting

Symptom	Check & Remedy
No operation	<ul style="list-style-type: none"> • Check if the power adapter is properly connected. • Check if the Ethernet cable is properly connected.
No dial tone	<ul style="list-style-type: none"> • Check if the handset cord is properly connected. • Check if the power adapter is properly connected.
LAN connection lost status message	<ul style="list-style-type: none"> • Check if the Ethernet cable is properly connected.
Cannot make call	<ul style="list-style-type: none"> • Check the status of your SIP registration status or contact your administrator, supplier or ITSP for more information or assistance.
Cannot receive a call	<ul style="list-style-type: none"> • Check if the Ethernet cable is properly connected. • Check the status of your SIP registration status, or contact your administrator, Distributor (dealer) or ITSP for more information or assistance.
One way voice	<ul style="list-style-type: none"> • Usually this is related to NAT transversal issue. Please contact your network vendor or service provider.
Cannot connect to the IP3062 configuration pages with a browser	<ul style="list-style-type: none"> • Check if the Ethernet cable is properly connected. • Check the IP address of the IP Phone. • Check if your firewall/NAT settings is correct.

9. Glossary

9.1. Acronyms

ANC	Anonymous Call
APS	Auto-Provisioning Server
B2BUA	Back to Back User Agent
CA	Certificate Authority
CID	Caller ID
CODEC	Coder and Decoder of Voice
CNG	Comfort Noise Generation
CPC	Calling Party Control
CPE	Customer Premises Equipment
CWCID	Call Waiting Caller ID
CWI	Call Waiting Indication
CWT	Call Waiting Tone
DHCP	Dynamic Host Configuration Protocol
DNS	Domain Name Server
DTMF	Dual Tone Multiple Frequency
ETSI	European Telecommunication Standard
FQDN	Fully Qualified Domain Name
FSK	Frequency Shift Keying
HTML	Hypertext Markup Language
HTTP	Hypertext Transfer Protocol
ICMP	Internet Control Message Protocol
IETF	Internet Engineering Task Force
IP	Internet Protocol
ISP	Internet Service Provider
ITSP	IP Telephony Service Provider
IVR	Interactive Voice Response
LAN	Local Area Network
LBR	Low Bit Rate
LBRC	Low Bit Rate Codec
MWI	Message Waiting Indication
PoE	Power over Ethernet (IEEE802.3af standard)
PPPoE	Point-to-point protocol over Ethernet (mainly for xDSL modem connection)
PSTN	Public Switched Telephone Network
NAT	Network Address Translation
NTP	Network Time Protocol
RTP	Real Time Protocol
RTCP	Real Time Control Protocol
SDP	Session Description Protocol
SIP	Session Initiation Protocol
TFTP	Trivial File Transfer Protocol
TCP	Transmission Control Protocol
UDP	User Datagram Protocol
URL	Uniform Resource Locator
VLAN	Virtual Local Area Network
WAN	Wide Area Network
XDSL	Digital Subscriber Loop, such as ADSL, VDSL, HDSL, etc.,.....
XML	Extensible Markup Language

9.2. Terminology

10/100BASE-T	It is a LAN transmission line specification stipulated by IEEE. Transmission speed is 10 or 100 Mbps and the modulation technique is base-band modulation. The cable uses unshielded twisted pair, similar to a telephone wire. 10BaseT is an IEEE standard (802.3) for operating 10 Mbps Ethernet networks (LANs) with twisted pair cabling and a wiring hub.
802.1p	An IEEE standard for providing QoS using three bits (defined in 802.1q) to allow switches to reorder packets based on priority level.
802.1q	An IEEE standard for providing virtual LAN (VLAN) identification and QoS levels. Three bits are used to allow eight priority levels, and 12 bits are used to identify up to 4,096 VLANs.
<u>AGC</u>	Automatic Gain Control is a feature of IP solutions units that allows the units to automatically adjust the incoming voice signal to a user defined level in dBm.
<u>A-law</u>	The PCM coding and compression standard used in Europe and in areas outside of North America influence. A Law Encoding is the method of encoding sampled audio waveforms used in 2.048Mbps, 30 channel PCM primary system known as E-carrier.
Auto answer	In telephone call control: The capability of a machine to answer a ringing telephone without human intervention.
Autodial	In telephone call control: An auxiliary device for a telephone that automatically dials any of a group of prerecorded telephone numbers.
Blocked Calls	Caused by an insufficient network facility that does not have enough lines to allow calls to reach a given destination. May also pertain to a call from an originating number that is blocked by the receiving telephone number.
Call Completion	The point at which a dialed number is answered.
Call Termination	The point at which a call is disconnected.
CDR	In telephone call control: Call Detail Record for billing
IP Centrex	This service is offered by the LEC to the end user. The feature-rich Centrex line offers the same features and benefits as a PBX to a customer without the capital investment or maintenance charges. The LEC charges a monthly fee to the customer, who must agree to sign a term agreement. And the above service is thru VoIP called IP centrex.
CO	Switching center for the local exchange carrier.
CODEC	The CODEC (CODER/DECODER) is a standard through which voice information can be encoded into data or decoded back to voice information. Both a Coder and Decoder are necessary on both sides of the telephone call since telephone calls occur simultaneously in both directions. Bandwidth is an extremely important factor in QOS (Quality of Service). MOS (Mean Opinion Score) is an attempt to make a quantifiable benchmark of voice quality. Below are examples of the CODEC, bit rate and mean opinion score: G.711 (toll quality) 64K MOS=4.1, G.726 16K (32K) MOS =3.8, G.729AB (cell phone quality) 8K MOS=3.7.

Customer Premise Equipment	The only part of the telecommunications system that the customer comes into direct contact with. Example of such pieces of equipment are: telephones, key systems, PBXs, voicemail systems and call accounting systems as well as wiring telephone jacks. The standard for this equipment is set by the FCC, and the equipment is supplied by an interconnect company.
DHCP	A utility that enables a server to dynamically assign IP addresses from a predefined list and limit their time of use so that they can be reassigned. Without DHCP, an IT Manager would have to manually enter in all the IP addresses of all the computers on the network. When DHCP is used, whenever a computer logs onto the network, it automatically gets an IP address assigned to it.
DID	Direct Inward Dialing: The ability to make a telephone call directly into an internal extension without having to go through the operator.
Diff-Serv	Differentiated Services : The Diff-Serv model divides traffic into a small number of classes to provide quality of service (QoS). One of QoS in internet
Direct inward dialing	A Centrex feature that allows an outside caller to dial a central business number, as well as an extension number.
Diversity antenna	A type of antenna system that uses two antennas to maximize reception and transmission quality and reduce interference.
DNS	Domain Name Service : A server/program that translates URLs to IP addresses by accessing a database maintained on a collection of Internet servers. The program works behind the scenes to facilitate surfing the Web with alpha versus numeric addresses. A DNS server converts a name like mywebsite.com to a series of numbers like 107.22.55.26. Every website has its own specific IP address on the Internet. Typically one or more DNS servers is located in an IP network.
DSL	Various technology protocols for high-speed data, voice and video transmission over ordinary twisted-pair copper POTS (Plain Old Telephone Service) telephone wires.
DSP	Digital Signal Processors (DSP) standardize the different states of a digital signal into an organized and understandable signal. DSP circuits can differentiate between digital signals and digital noise. Signal-to-Noise ratio is one of the most important factors in telephony voice communication because if there is too much noise in a signal, the DSP will be unable to find a signal standard and lose it. DSP circuits always adjust digital signal levels so the can maintain a standard without noise.
DTMF	Dual Tone Multi-Frequency: The type of audio signals generated when you press the buttons on a touch-tone telephone. Can be used in inbound(after voice channel connected) and outbound(before voice channel connected) application.
Ethernet	International standard networking technology for wired implementations. Basic 10BaseT networks offer a bandwidth of about 10 Mbps. Fast Ethernet (100 Mbps) and Gigabit Ethernet (1000 Mbps) are becoming popular.
G.711	64 kbps PCM half-duplex codec (high quality, high bandwidth, minimum processor load)

G.723.1	6.4/5.3 kbps MP-MLQ codec (low quality, low bandwidth, high processor load due to the compression)
G.726	40/32/24/16 ADPCM codec (good quality, medium bandwidth, low processor load)
G.729	8 kbps ACELP codec (medium quality, low bandwidth, high processor load)
IEEE	Institute of Electrical and Electronics Engineers, New York, www.ieee.org . A membership organization that includes engineers, scientists and students in electronics and allied fields. It has more than 300,000 members. The IEEE is an international organization that develops standards for hundreds of electronic and electrical technologies for computers and communications. The organization uses a series of numbers, like the Dewey Decimal system in libraries, to differentiate between the various technology families.
IP (Internet Protocol)	Internet Protocol is located at 3rd layer of ISO network model. A set of rules used to send and receive messages at the Internet address level. IP protocol is widely used in Internet and LAN networks. The purpose is to deliver data between computing equipment over the network. The protocol is generally effective but does not guarantee complete and accurate data communications.
IP address	A 32-bit number that identifies each sender or receiver of information that is sent across the Internet. An IP address has two parts: an identifier of a particular network on the Internet and an identifier of the particular device (which can be a server or a workstation) within that network. A number used to identify the location of a host device. It is expressed in numeric dot notation (e.g. 202.203.27.31).
IP Centrex	This service is offered by the LEC to the end user. The feature-rich Centrex line offers the same features and benefits as a PBX to a customer without the capital investment or maintenance charges. The LEC charges a monthly fee to the customer, who must agree to sign a term agreement. And the above service is thru VoIP called IP centrex.
Jitter	Jitter refers to fluctuations in transmission delay time. In the case of voice data, conversations are packaged into packets (IP packetization) and transmitted. Individual packets can take different routes through the varied networks that comprise the Internet. When the time interval for the arrival of the packets is not constant the timing fluctuations that may occur are referred to as "jitter".
MAC	Medium Access Controller (MAC) : The IEEE 802.11 Standard encompasses the physical layer (PHY) and the lower portion of the data link layer. The lower portion of the data link layer is often referred to as the Medium Access Controller (MAC) sublayer. Every wireless 802.11 device has its own specific MAC address hard-coded into it. This unique identifier can be used to provide security for wireless networks. When a network uses a MAC table, only the 802.11 radios that have had their MAC addresses added to that network's MAC table will be able to get onto the network.

NAT	Network Address Translation: A network capability that enables a houseful of computers to dynamically share a single incoming IP address from a dial-up, cable or xDSL connection. NAT takes the single incoming IP address and creates new IP address for each client computer on the network.
Numbering plan	In a communications network, a numbering plan allocates specific numeric codes to identify each subscriber line, special lines, trunk lines, etc. Numbering plans can be divided into the numbering system and number assignments. The numbering system indicates the number of digits to be assigned and the basic scheme of number assignment. The assignment of specific codes is performed according to the numbering system.
PBX	Private Branch Exchange: An in-house telephone switching system that interconnects telephone extensions to each other as well as to the outside telephone network.
Peer-to-peer network	A wireless or wired computer network that has no server or central hub or router. All the networked PCs are equally able to act as a network server or client, and each client computer can talk to all the other wireless computers without having to go through an access point or hub. However, since there is no central base station to monitor traffic or provide Internet access, the various signals can collide with each other, reducing overall performance.
POTS	Plain Old Telephone Service (POTS), or Pretty Old Telephone System is the standard analog traditional telephone service that most homes use. In contrast, telephone services based on high-speed, digital communications, such as ISDN and DSL, are not POTS. The main distinctions between POTS and non-POTS services are speed and bandwidth.
Proxy server	Used in larger companies and organizations to improve network operations and security, a proxy server is able to prevent direct communication between two or more networks. The proxy server forwards allowable data requests to remote servers and/or responds to data requests directly from stored remote server data.
PSTN	Public Switched Telephone Network: The worldwide voice telephone network.
QoS	Quality of service (QoS)
RJ-45	Standard connectors used in Ethernet networks. Even though they look very similar to standard RJ-11 telephone connectors, RJ-45 connectors can have up to eight wires, whereas telephone connectors have only four.
Router	A device that forwards data packets from one local area network (LAN) or wide area network (WAN) to another. Based on routing tables and routing protocols, routers can read the network address in each transmitted frame and make a decision on how to send it via the most efficient route based on traffic load, line costs, speed, bad connections, etc.

RTP/RTCP	Real-Time Protocol/Real-Time Control Protocol(RTP / RTCP) : IETF specifications for audio and video signal management. Allows applications to synchronize and spool audio and video information. RTP (Real Time Protocol) is specifically concerned with the dependable transmission of latency-sensitive traffic across the network and is involved in using time stamping to determine network jitter tolerance and makes sure that voice packets are arriving in order.
SIP	Session Initiation Protocol: A protocol that provides telephony services similar to H.323, but is less complex and uses less resources. SIP (Session Initiation Protocol) is a signaling protocol for Internet conferencing, telephony, presence, events notification and instant messaging. SIP is a text-based protocol, similar to HTTP and SMTP, for initiating interactive communication sessions between users.
Subnetwork or Subnet	Found in larger networks, these smaller networks are used to simplify addressing between numerous computers. Subnets connect to the central network through a router, hub or gateway. Each individual wireless LAN will probably use the same subnet for all the local computers it talks to.
TCP/IP	Internet Standard Protocol: The underlying technology behind the Internet and communications between computers in a network. The first part, TCP, is the transport part, which matches the size of the messages on either end and guarantees that the correct message has been received. The IP part is the user's computer address on a network. Every computer in a TCP/IP network has its own IP address that is either dynamically assigned at startup or permanently assigned. All TCP/IP messages contain the address of the destination network as well as the address of the destination station. This enables TCP/IP messages to be transmitted to multiple networks (subnets) within an organization or worldwide.
TOS	Type of Service: A method of setting precedence for a particular type of traffic for QoS.
UDP	User Datagram Protocol. An unreliable networking layer that sits at the same level of the networking stack as TCP. UDP is a connectionless transport protocol that is part of a suite of protocols (the others being RTP and IP) that allow for the timely and efficient transfer of voice data across and IP network. UDP is the better transport protocol for VoIP data than TCP.
VAD	Voice Activity Detection (VAD) helps save bandwidth during calls. Examples: When you are making a VoIP call and you are not speaking and you are listening, that silence is still taking up bandwidth during the call. When silence is detected by VAD software over a predetermined length of time, it sends silent packets that inform other VAD enabled systems to stop holding the bandwidth for these empty packets.

VoIP	<p>Voice Over Internet Protocol: VoIP is based on the principal of transmitting digitized voice packets over networks. Basically, VoIP consists of converting voice signals into streams of digital packets and sending those packets of data through an IP-constructed network environment. VoIP can work in both LAN (local area network) and WAN (wide area network) environments for intranetwork or internetwork communication between VoIP channel users. Routers and switches and other special compression protocols direct the packetized voice data to their destination IP address. VoIP can be less expensive than voice transmission using standard analog packets over POTS (Plain Old Telephone Service). It allows telephone calls, faxes, or overhead paging to be transported over an existing IP data network topology.</p>
VPN	<p>Virtual Private Network(VPN) is a virtual created sub-network based on a public real network. A type of technology designed to increase the security of information transferred over the Internet. VPN can work with either wired or wireless networks, as well as with dial-up connections over POTS. VPN creates a private encrypted tunnel from the end user's computer, through the local wireless network, through the Internet, all the way to the corporate servers and database.</p>
WAN	<p>Wide Area Network: For global or long distance networking access thru the support of telecommunication devices. A communication system of connecting PCs and other computing devices across a large local, regional, national or international geographic area. Also used to distinguish between phone-based data networks and Wi-Fi. Phone networks are considered WANs and Wi-Fi networks are considered Wireless Local Area Networks (WLANs).</p>
WLAN	<p>Also referred to as LAN. A type of local-area network that uses high-frequency radio waves rather than wires to communicate between nodes.</p>

===== The End of Document =====